

VIDREPUR

CATÁLOGO GENERAL · GENERAL CATALOGUE

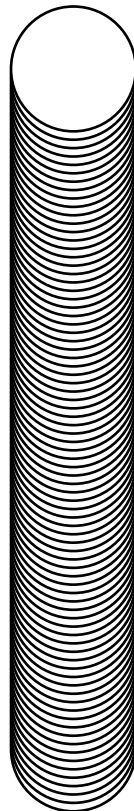
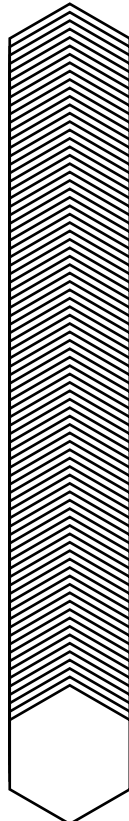
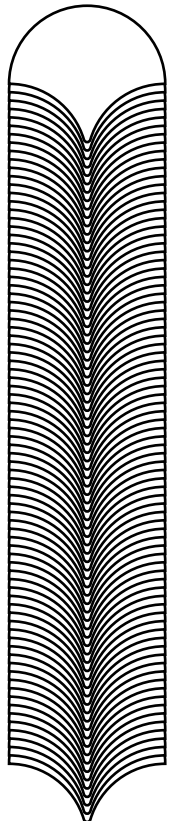
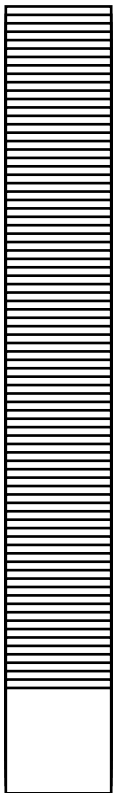
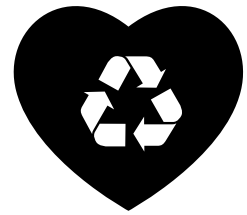

2021/22

RECICLANDO DESDE 1988
RECYCLING SINCE 1988
NOUS RECYCLONS DEPUIS 1988

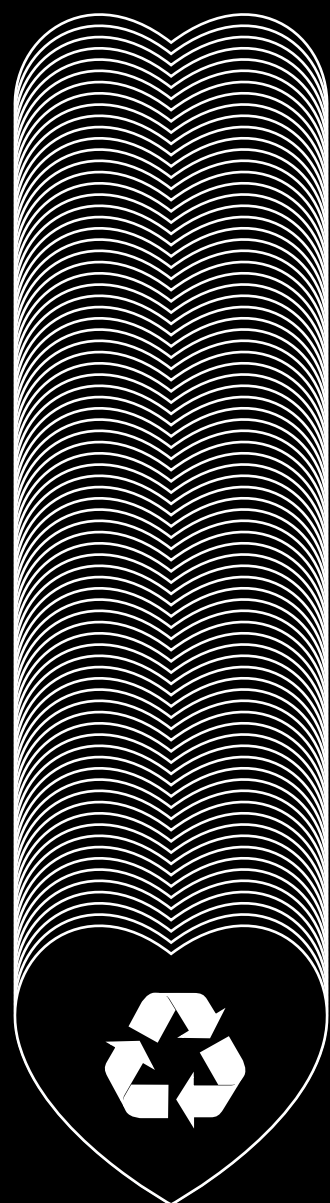

Tradición y arte se aúnan a lo largo de más de 30 años en vidrepur, líder en la fabricación y distribución de mosaico vítreo. Manos expertas, diseños de vanguardia e innovación han conseguido que vidrepur pueda aportar en este catálogo las colecciones que permiten decorar los espacios con más personalidad.

Vidrepur posee su planta principal en castellón, y cuenta con delegaciones en estados unidos y méxico, además, más de 4000 distribuidores han confiado en su servicio y calidad en todo el mundo. Nuestros productos son fabricados en su totalidad en nuestra planta de españa y están compuestos por material 99% reciclado

Desde nuestros inicios y como valor fundamental, se encuentra el cuidado y respeto al medio ambiente en todos sus aspectos. Certificados y garantías de este valor añadido avalan nuestros productos y son garantía de calidad y responsabilidad social.

Tradition an art does blend through more than 30 years in vidrepur, a leader in production and distribution of glass mosaics. Expertise, avant-garde designs and innovations, allows vidrepur to provide in this catalogue the collections which enable you decorating with more personality.

Vidrepur has its production in castellón, spain. With its own distribution and sales offices in the usa and mexico, there is a worldwide, network more than 4000 clients who represent our style and quality. Our products are fully manufactured in our spanish factory and are made of 99% recycled material.

Since our beginning and as a fundamental value, is the care and respect for the environment in all its aspects. Several certificates and guarantees of this added value, support our glass mosaic product and ensures quality and social responsibility.

Tradition et art s'unissent depuis plus de 30 ans dans cette entreprise, leader dans la fabrication et la distribution de mosaïques en verre. Mains expertes, designs d'avant-garde et innovation ont permit à vidrepur de créer les collections qui décorent les espaces avec plus de personnalité.

Vidrepur a une usine principale à castellon, et des agences aux états-unis et aux mexique, sans compter les plus de 4000 distributeurs qui ont fait confiance en ses services et sa qualité partout dans le monde. Nos produits sont entièrement fabriqués dans notre usine située en espagne et sont composés de matériaux recyclés à 99%.

Depuis nos débuts nous avons comme valeurs fondamentales le soin et le respect de l'environnement dans tous ces aspects. Certificats et garanties de ces valeurs ajoutées garantissent nos produits, la qualité et la responsabilité sociale.



MADE WITH 100% RECYCLED CONTENT
PRE-CONSUMER

EMPRESA	02 - 03
ATELIER LAB	230 - 231
PROYECTOS	232 - 235
SOLUCIONES TÉCNICAS	238 - 258
REFERENCIAS	236 - 237
TECHNOCLEAN	212 - 215

INDEX

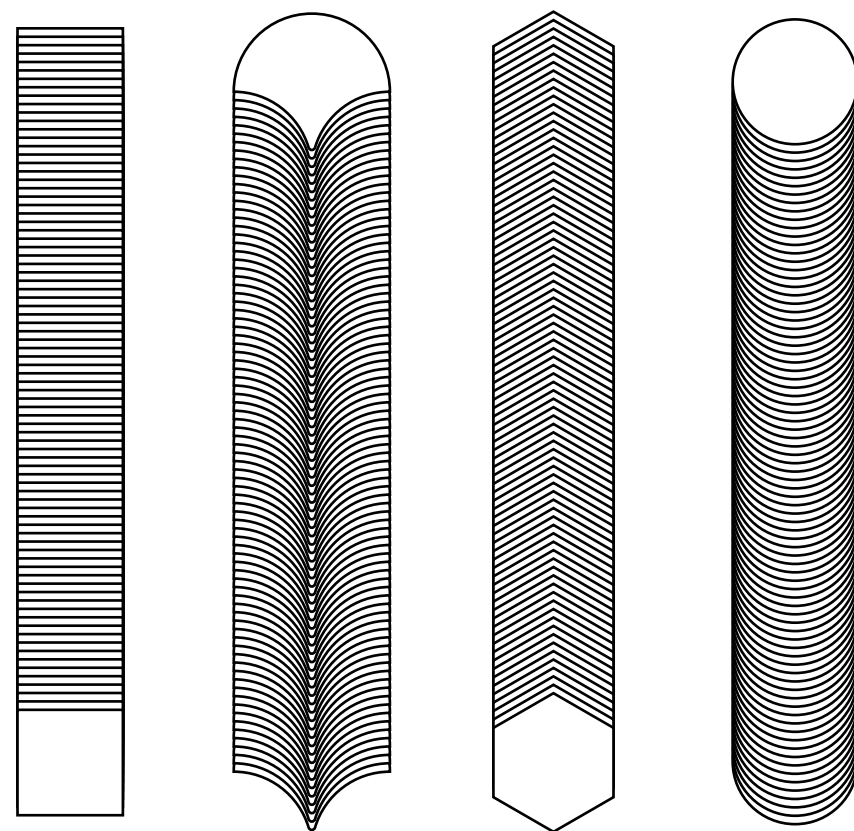

■ ◡ ● ○	ANTARCTICA	25X25 · H35	78 - 81
■ ◡ ● ○	ANTISLIP	25X25 · H35	204 - 211
■ ◡ ◊ ○	ARTS	25X25	154 - 155
■ ◡ ◊ ○	BIJOU	12X25	130 - 133
■ ◡ ◊ ○	BORN	25X25	126 - 129
□ ◡ ◊ ●	CIRCLE	25X25	30 - 41
■ ◡ ◊ ○	COLORS LISOS NIEBLAS	25X25	192 - 199
■ ◡ ◊ ○	COLORS +	25X25	200 - 203
■ ◡ ◊ ○	DEGRADADOS	25X25	216 - 221
□ ◡ ● ○	DESERT	H35	112 - 113
□ ◡ ● ○	DIAMOND	H35	134 - 137
□ ◡ ◊ ○	DIMENSION	36X29	14 - 29
■ ◡ ◊ ○	ELEMENTS	25X25	138 - 145
□ ◡ ● ○	ELITE	H35	82 - 85
■ ◡ ◊ ○	FUSION	25X25	184 - 187
□ ◡ ● ○	LEGEND	H35	96 - 97
■ ◡ ◊ ○	LUMINISCENTE	25X25	226 - 229
■ ◡ ● ○	LUX	25X25 · H35	172 - 177
■ ◡ ● ○	MAGIC	25X25 · H35 · 36X29	8 - 11
■ ◡ ● ○	MARBLES	25X25 · H35	114 - 123
■ ◡ ◊ ○	MEZCLAS BLENDS	25X25	222 - 225
■ ◡ ◊ ○	MOON	25X25	150 - 153
■ ◡ ◊ ○	NATURE GLOSS	25X25 · 38X38	158 - 167
■ ◡ ◊ ○	NATURE MATT	25X25 · 38X38	168 - 171
■ ◡ ● ○	NORDIC	25X25 · H35 · 36X29	62 - 75
□ ◡ ◊ ●	PEARL	12X12	146 - 149
■ ◡ ● ●	SHELL	25X25 · H35	178 - 183
□ ◡ ◊ ○	SOUL	36X29	42 - 61
■ ◡ ● ○	STONES	25X25 · H35	98 - 105
■ ◡ ● ○	SUPREME	25X25 · H35	122 - 123
■ ◡ ◊ ○	TITANIUM	25X25	188 - 191
□ ◡ ● ○	TERRE	25X25	106 - 111
■ ◡ ● ○	WOODS	25X25 · H35	88 - 95



6

47 MAGIC SILVER SOUL



MAGIC COLLECTION

La magia sí existe. Aparece cuando te cruzas con cosas bellas en tu día a día, con nuevos trabajos repletos de ilusión que te hacen sentir, reír y dejar de lado lo que ya no suma y tú; crees en la magia ?

Yes, we believe in magic. She appears when you cross into beautiful things, and in our world, when you think you want to return at home. Yes, we believe in magic, and you?

La magie existe bien. Elle apparaît au quotidien quand nous croisons de belles choses, elle apparaît par de nouveaux projets emplis d'illusion qui vous font sentir, rire et laisser de côté ce qui ne colle pas. Et vous, la magie, vous y croyez ?

7





8

48/D MAGIC COPPER HEX



9

49 MAGIC GOLD

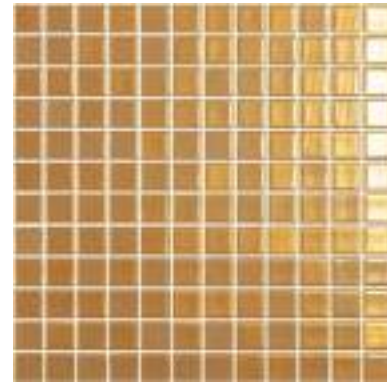

49 MAGIC GOLD

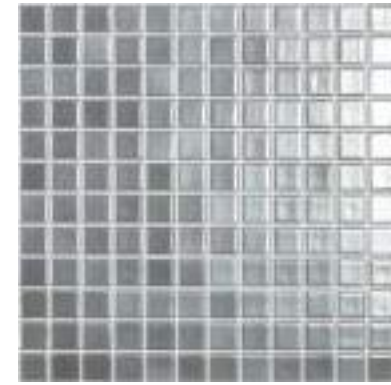

47 MAGIC SILVER



48 MAGIC COPPER

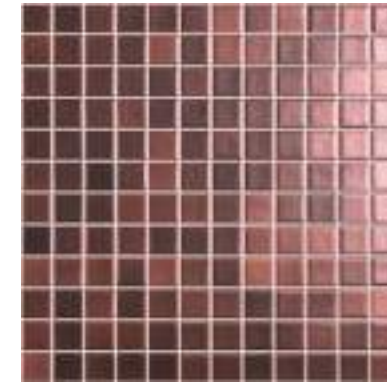

45 MAGIC BRONZE

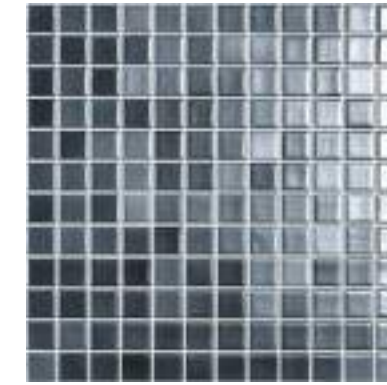

46 MAGIC BLACK

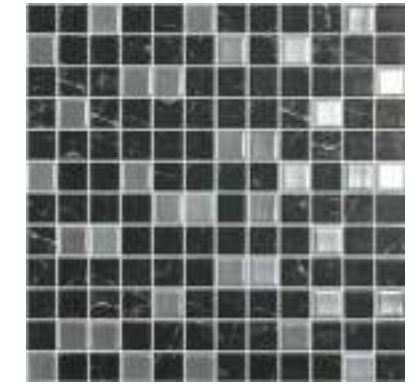

MAGIC ROME BLEND

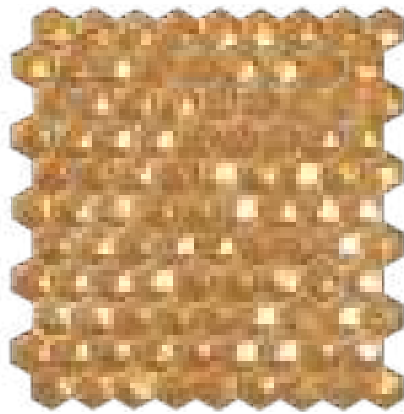

49/D MAGIC GOLD HEX

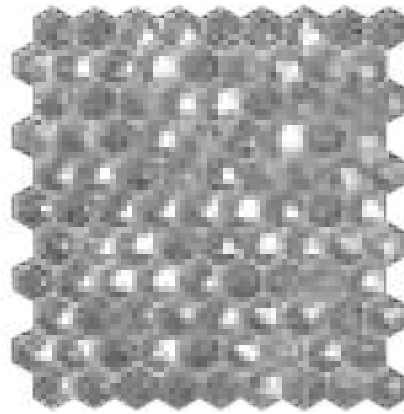

47/D MAGIC SILVER HEX

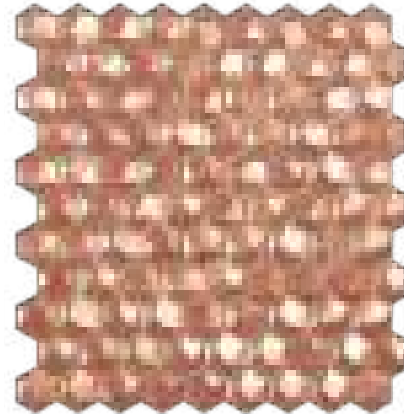

48/D MAGIC COPPER HEX

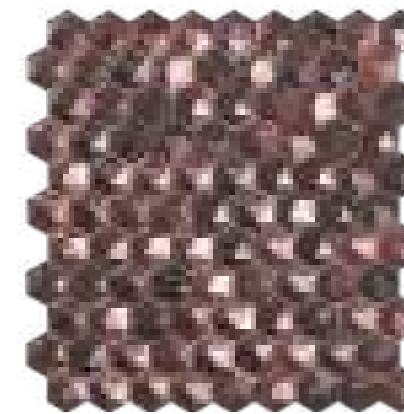

45/D MAGIC BRONZE HEX

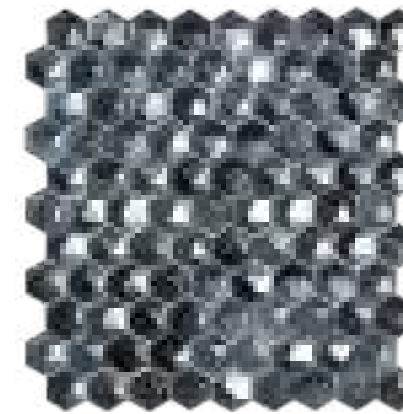

46/D MAGIC BLACK HEX



MAGIC CLASSIC BLEND

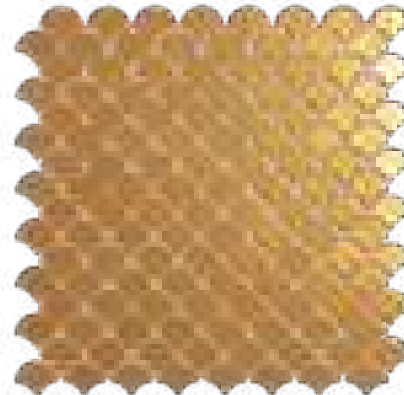

49 MAGIC GOLD SOUL

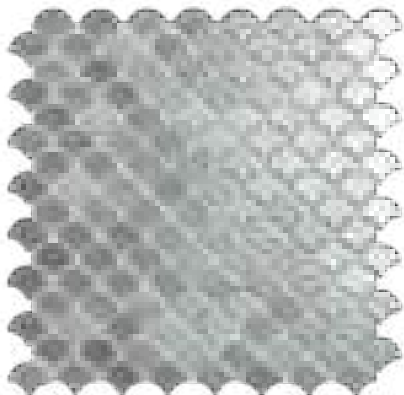

47 MAGIC SILVER SOUL

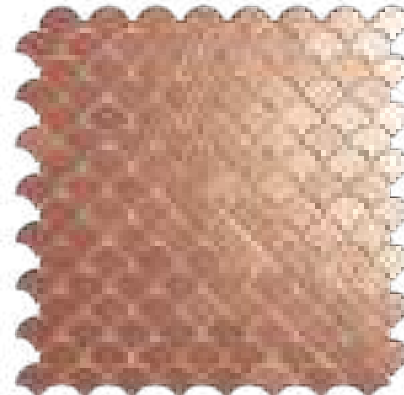

48 MAGIC COPPER SOUL

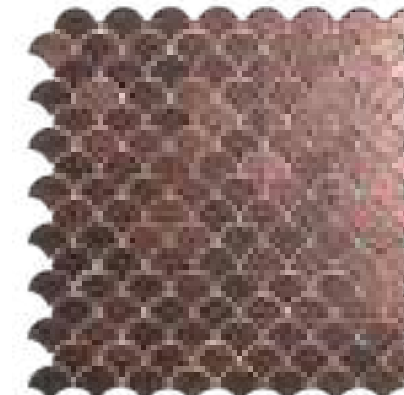

45 MAGIC BRONZE SOUL

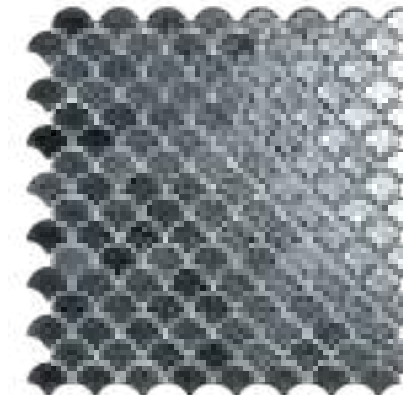

46 MAGIC BLACK SOUL

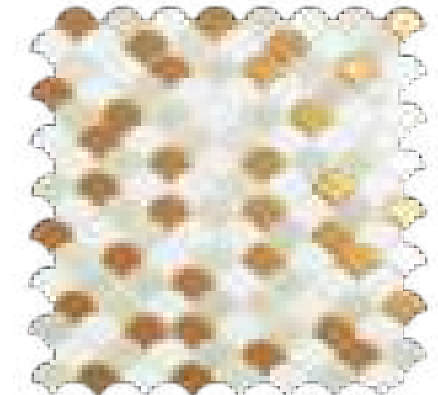

MAGIC LUX SOUL BLEND

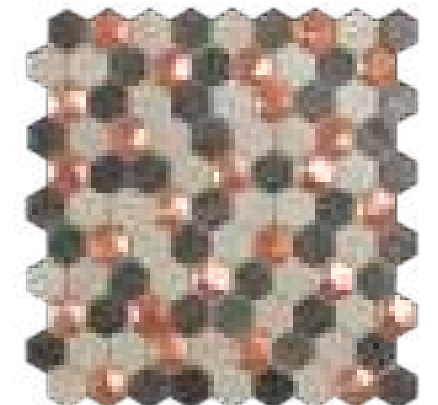

MAGIC TREND BLEND

FORMATO - SIZE	PLACA SHEET PLAQUE			CAJA BOX CAISSE			PALET PALLET PALETTE		
	PIEZAS PIECES	MEDIDA DIMENSIONS	KGS KGS	PLACAS SHEET	M ² SQM	KGS KGS	CAJAS BOXES	M ² SQM	KGS KGS
25x25 MM	144	315x315	0,90	10	1	9	126	126	1.134,00
35x35 MM D	99	317x307	1,10	10	0,87	10,96	126	109,62	1.380,96
36x29 MM S	128	324x317	0,99	10	0,87	9,93	126	109,62	1.251,18



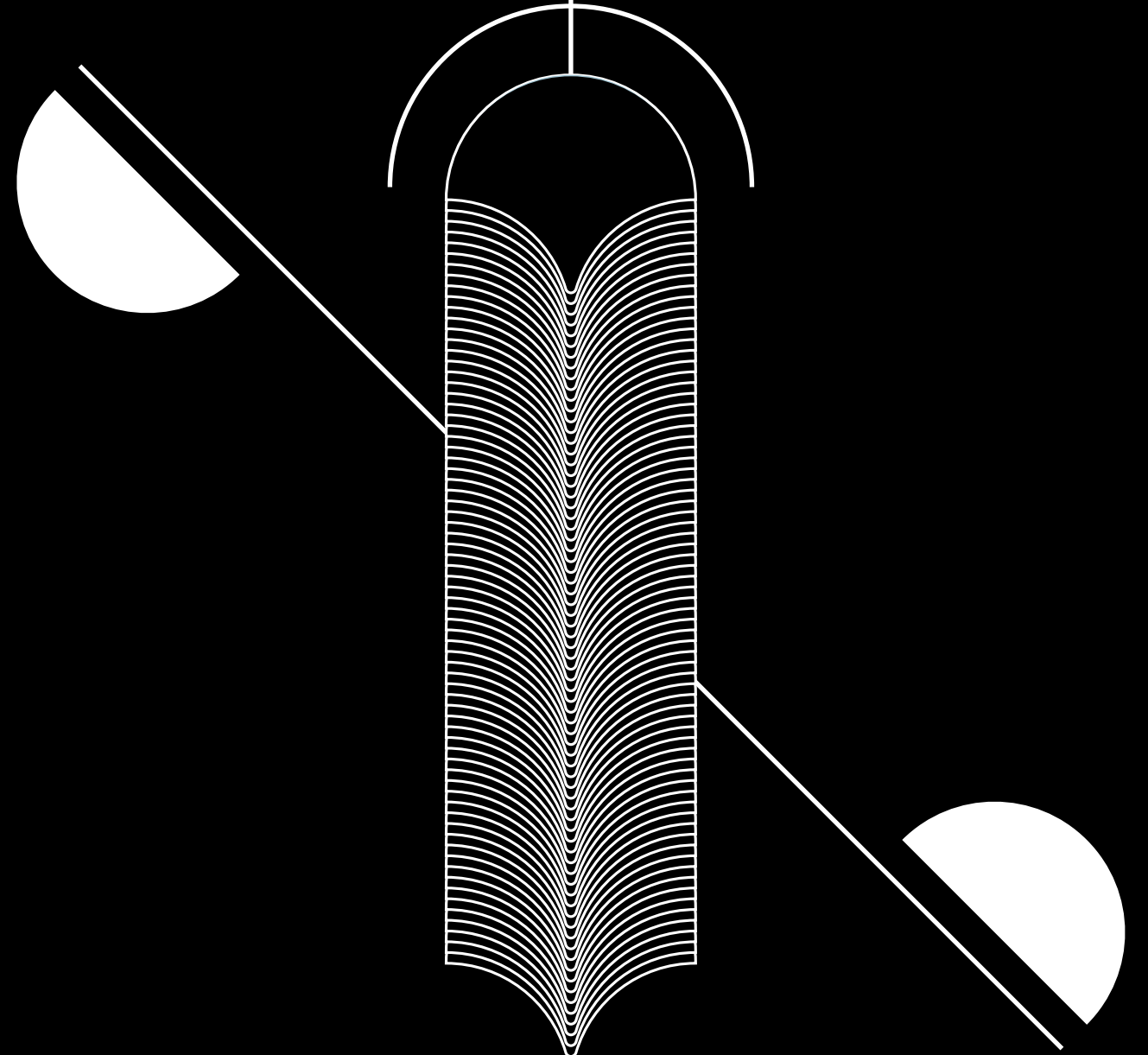
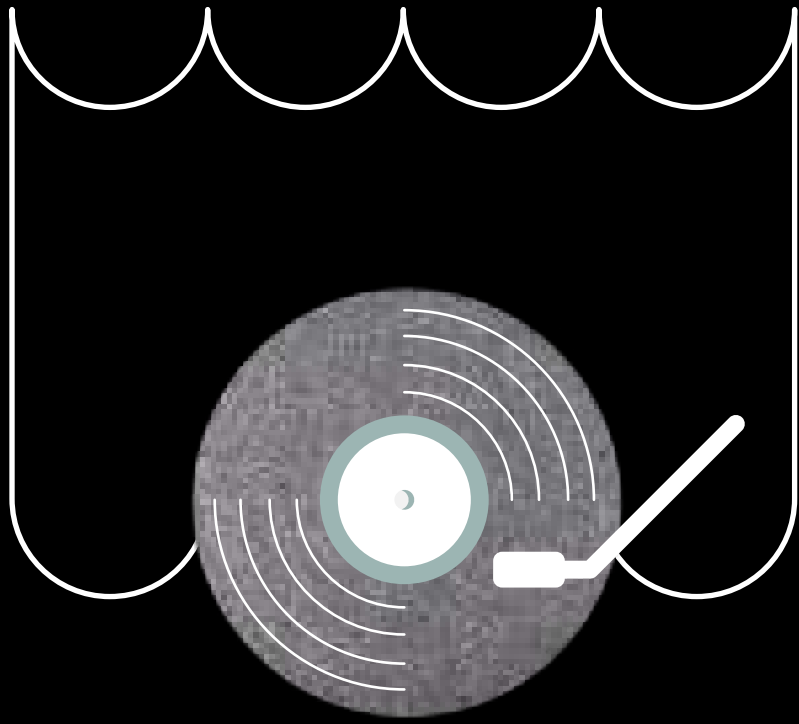

GEOMETRIC SHAPES

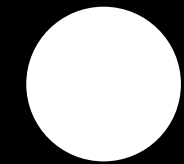
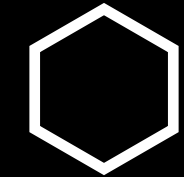
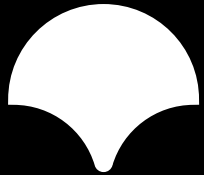
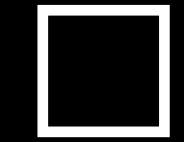



14

6007/E DIMENSION TENDER BR



DIMENSION COLLECTION

No se trata de colores y formas, las nuevas colecciones de Vidrepur transmiten sensaciones y nuevas experiencias.

Dimension Collection by Vidrepur ha nacido con el propósito de embellecer tus proyectos y reformas y como Frank Lloyd escribió " si inviertes en belleza se quedará contigo todos los días de tu vida "

Rather than being simply colours and shapes, Vidrepur's new collections convey sensations and new experiences.

Dimension collection by Vidrepur came into being with the aim of embellishing your projects and refurbishments. As Frank Lloyd once wrote: "if you invest in beauty, it will remain with you all the days of your life."

Il ne s'agit pas de couleurs ni de formes, les nouvelles collections Vidrepur transmettent des sensations et de nouvelles expériences.

Dimension Collection by Vidrepur est née avec l'objectif d'embellir vos projets et rénovations, à l'instar de ce qu'a écrit Frank Lloyd « si tu investis dans la beauté, elle restera avec toi tous les jours de ta vie »

DISCOVER
OTHER
DIMENSION



15



16

4300/E CARRARA GREY MT



17

MARBLE COLLECTION | 3,6x2,9 | 1.5"x1"



4300/E CARRARA GREY MT



MARBLES HESTIA ORNAMENTAL



MARBLES HESTIA ORNAMENTAL



20

6005/E DIMENSION BLACK BR

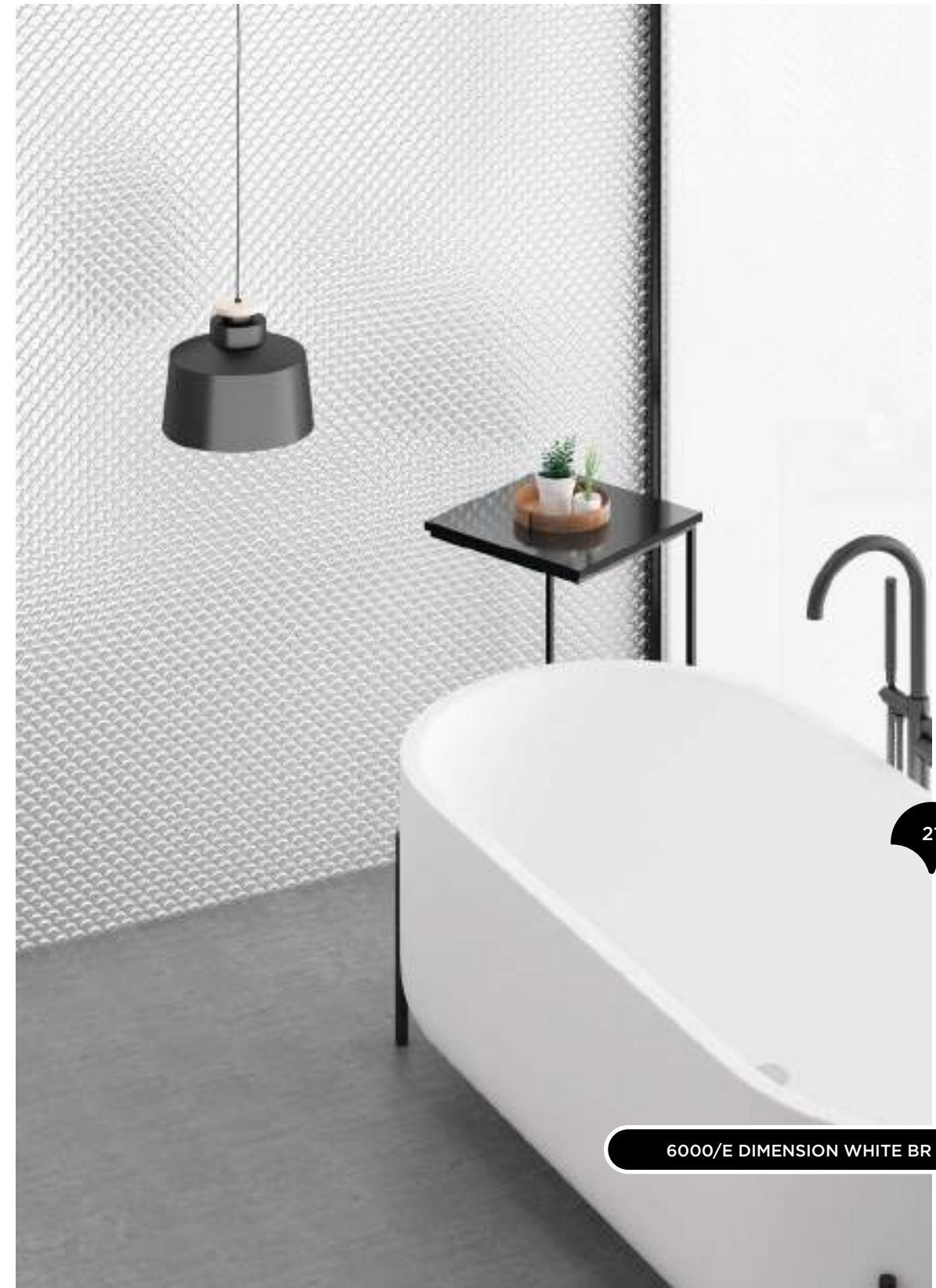

21

6000/E DIMENSION WHITE BR







6005/E DIMENSION BLACK BR



6006/E DIMENSION JADE BR





6000/E DIMENSION WHITE BR

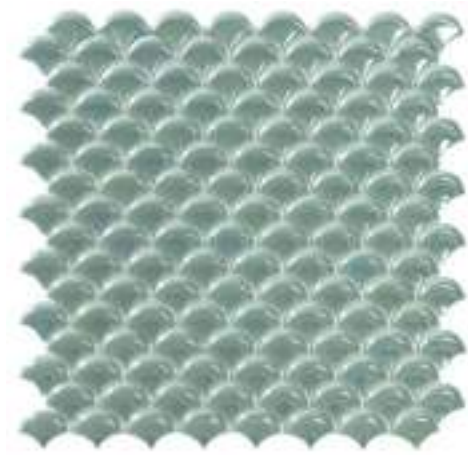

6006/E DIMENSION JADE BR

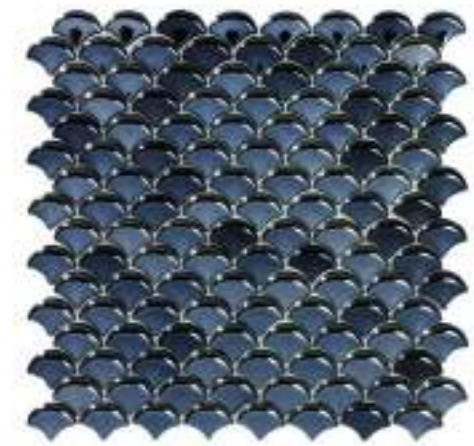

6005/E DIMENSION BLACK BR

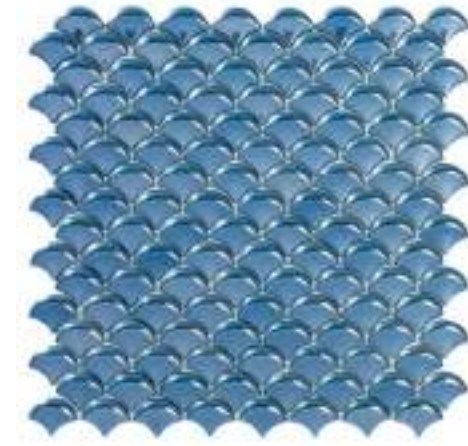

6004/E DIMENSION DARK BLUE BR



6008/E DIMENSION NAVY BR

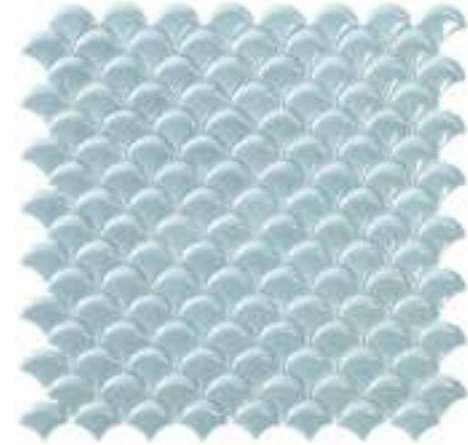

6007/E DIMENSION TENDER BR

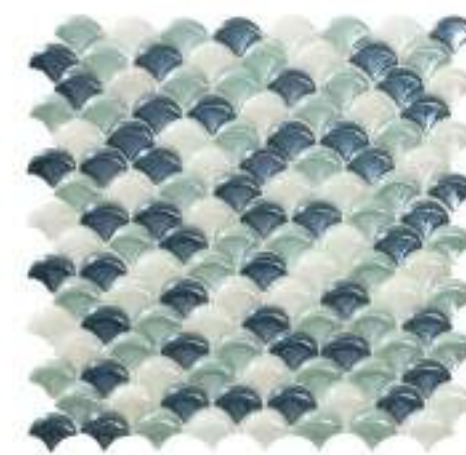

DIMENSION CIRCE BLEND



DIMENSION NIKÉ BLEND



* DIMENSION NIX ORNAMENTAL BLEND

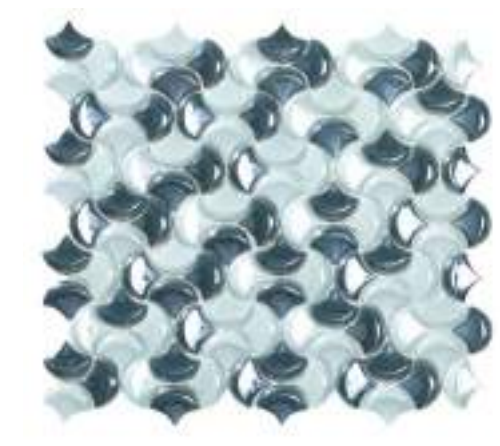

* DIMENSION SELENE ORNAMENTAL BLEND

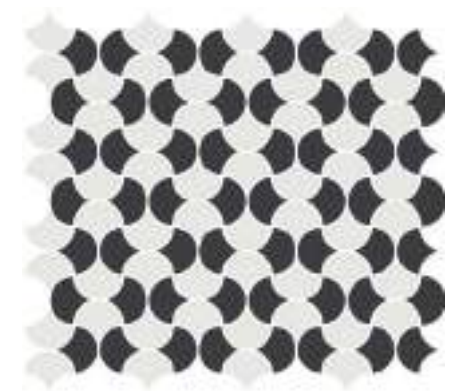

DIMENSION ORNAMENTAL DESIGN

* EL DISEÑO DE LAS MEZCLAS ORNAMENTALES PUEDE PRESENTARSE CON DISEÑO ORDENADO.
 * THE DESIGN OF ORNAMENTAL BLENDS CAN BE PRESENTED WITH ORDERED SET UP
 * LE DESIGN DE MÉLANGES ORNEMENTAUX PEUT SE PRÉSENTER COMME UN DESIGN ORDONNÉ.

FORMATO - SIZE	PLACA SHEET PLAQUE			CAJA BOX CAISSE			PALET PALLET PALETTE		
	PIEZAS PIECES	MEDIDA DIMENSIONS	KGS KGS	PLACAS SHEET	M ² SQM	KGS KGS	CAJAS BOXES	M ² SQM	KGS KGS
36x29E MM BR	128	324x317	1,418	10	0,87	14,180	63	54,81	893,34
36x29E MM ORNAMENTAL	112	294X325	1,32	10	0,82	13,206	63	51,66	682,22

* LOS PALETS NO SE PUEDEN APILAR / PALLETS CANNOT BE STACKED

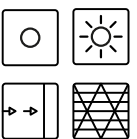



CIRCLE AQUA BLACK BLEND

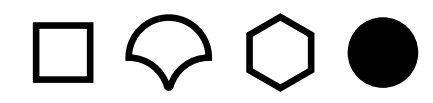

CIRCLE COLLECTION

Descubre con nosotros innovaciones increíbles en mosaico vítreo, con una nueva experiencia en formatos, colores y texturas que seguro te sorprenderán.

El nuevo formato circular que propone experiencias en decoración novedosas y una nueva propuesta de recubrir la piscina de forma original y creativa.

Discover with us the ultimate innovations in glass mosaic. A great experience plenty of new ideas, new shapes and sizes, new colors and finishes.

These novelties includes a new shape, that are giving us a lot of design possibilities and uses: decoration o swimming pools, the circle is an amazing solution in the glass mosaic world.

Venez découvrir avec nous d'incroyables innovations en mosaïque vitrée, avec une nouvelle expérience de formats, couleurs et textures qui vous surprendront indubitablement.

Le nouveau format circulaire offre des expériences de décoration innovantes, une nouvelle proposition pour recouvrir la piscine d'une manière originale et créative.

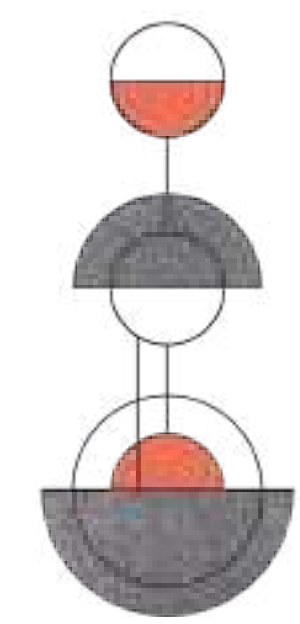



32

6000 CIRCLE WHITE BR



33





34

6001 CIRCLE TURQUOISE BR



35

CIRCLE GREEN MIX



6108 CIRCLE BLACK MT



6106 CIRCLE WHITE MT





6005 CIRCLE BLACK BR



6002 CIRCLE LIVE CORAL BR

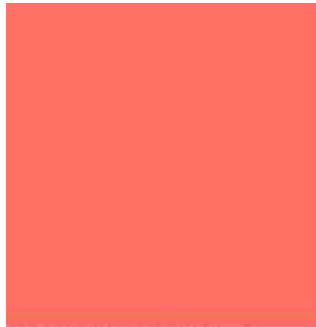

PANTONE®
16-1546
Living Coral



CIRCLE COLLECTION

25x25 MM | 1"x1" 

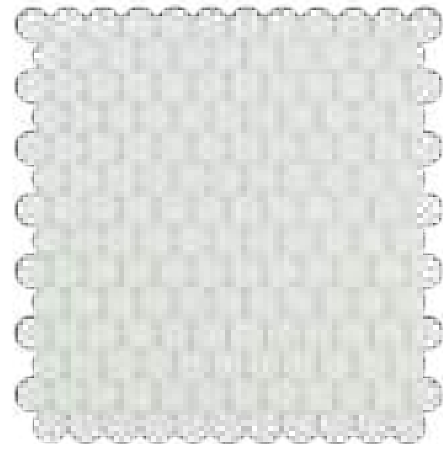

6106 CIRCLE WHITE MT



6108 CIRCLE BLACK MT



CIRCLE AQUA BLACK BLEND

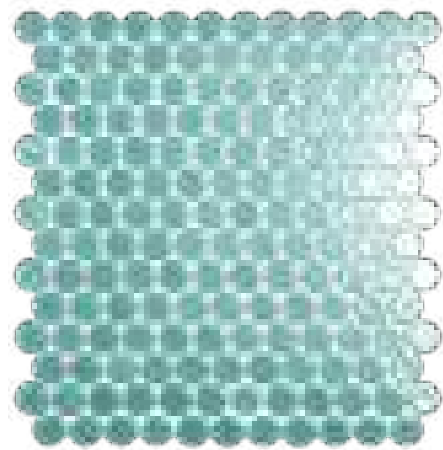

6001 CIRCLE TURQUOISE BR



6004 CIRCLE DARK BLUE BR

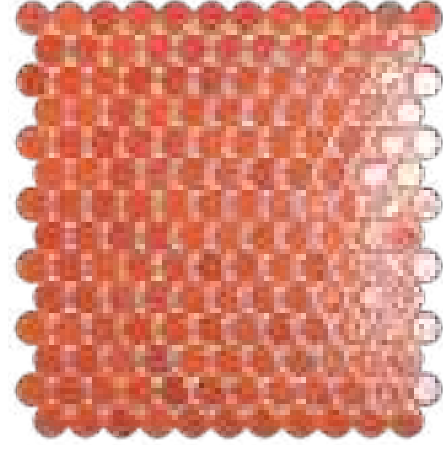

6002 CIRCLE LIVE CORAL BR



6000 CIRCLE WHITE BR



6005 CIRCLE BLACK BR

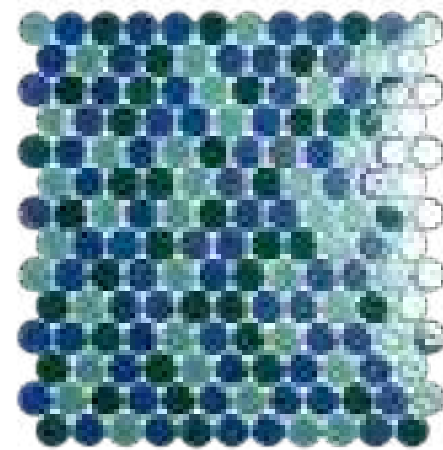

GREEN MIX CIRCLE

FORMATO - SIZE	PLACA SHEET PLAQUE			CAJA BOX CAISSE			PALET PALLET PALETTE		
	PIEZAS PIECES	MEDIDA DIMENSIONS	KGS KGS	PLACAS SHEET	M ² SQM	KGS KGS	CAJAS BOXES	M ² SQM	KGS KGS
25x25 MM	161	30.6x31.4	0.88	13	1,19	11,4075	126	149.94	1.437,35

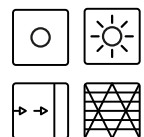

6004 CIRCLE DARK BLUE BR



SOUL FRAPPE MIX



SOUL COLLECTION

Nuevas formas, nuevas ideas, clásicos renovados que marcarán tendencia en todos los ámbitos. El hogar, zonas comerciales, spas, piscinas. Atrevámonos a decorar y personalizar nuestro entorno de forma creativa y original. Esta forma utilizada en mosaico durante muchos años, se renueva, y nos permite crear ambientaciones actuales, modernas y llenas de vida.

Los colores, también obtenidos por un lado gracias a la naturaleza, turquesas y verdes brillantes, y por otro, tonalidades neutras; nudes, negros y grises para las opciones más minimalistas y que vemos en la moda y las tendencias en el hogar.

New shapes, new ideas, renewed classics to set the trend everywhere. At home, malls, spas and swimming pools. Dare us to decorate and personalize our surroundings in a creative and original way. This shape has been used in mosaic for many years and has now been renewed, allowing us to create a modern ambiance, full of life.

The colours, obtained on the one hand thanks to nature – turquoises and brilliant greens, and on the other, there are neutral tones - different shades of nude, black and grey for the most minimalist options seen in fashion and home trends.

De nouvelles formes, de nouvelles idées, des classiques renouvelés qui donnent le ton dans tous les domaines. La maison, les zones commerciales, les spas, les piscines. Osons décorer et personnaliser notre environnement de manière créative et originale. Cette forme utilisée dans la mosaïque pendant des années se renouvelle et nous permet de créer des ambiances actuelles, modernes et pleines de vie.

Les couleurs obtenues de la nature d'une part, les turquoises et les verts brillants, et des tonalités neutres d'autre part, des nus, des noirs et des gris, pour les options les plus minimalistes que nous apercevons dans la mode et les tendances de l'habitat.





44

6104 SOUL BLUE MT



45

6104 SOUL BLUE MT



46



6003 SOUL GREEN BR



47

6107 SOUL GREEN MT





50

6000 SOUL WHITE BR



51

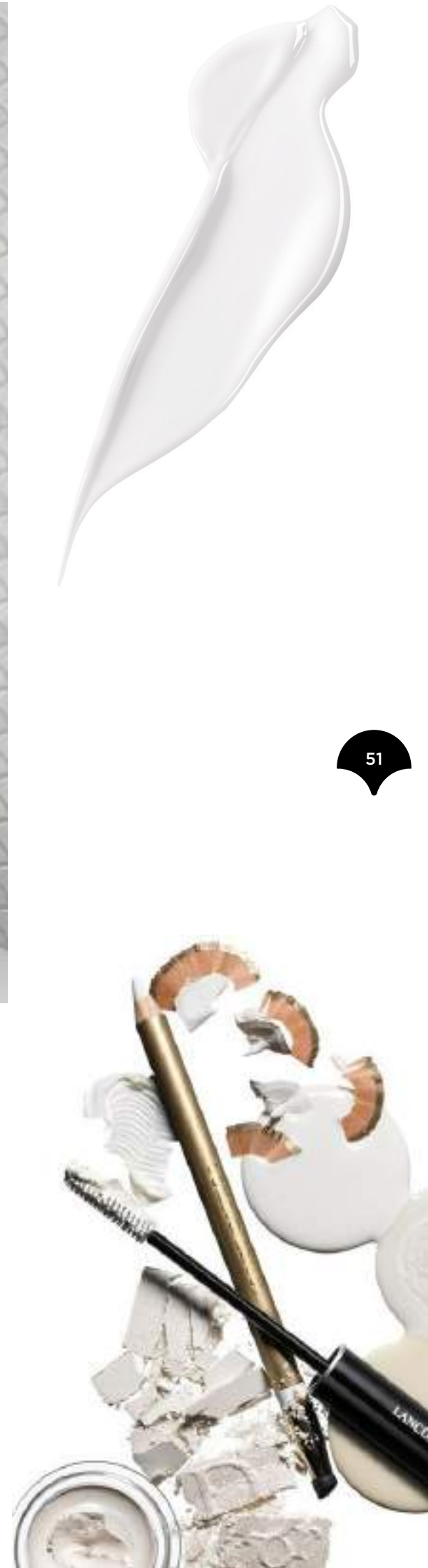



52

6101 SOUL TURQUOISE MT



53

SOUL BLUE MIX





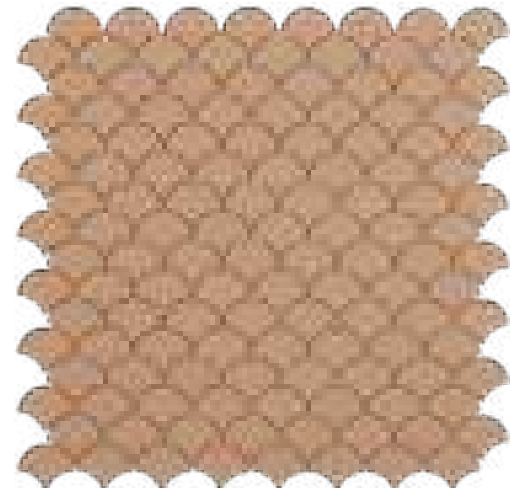

6102 SOUL BEIGE MT

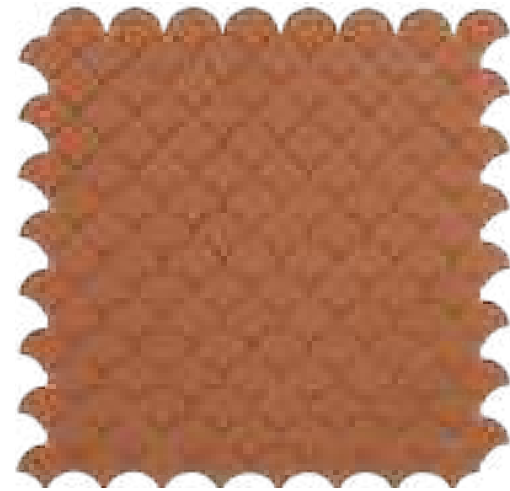

6103 SOUL MOKA MT

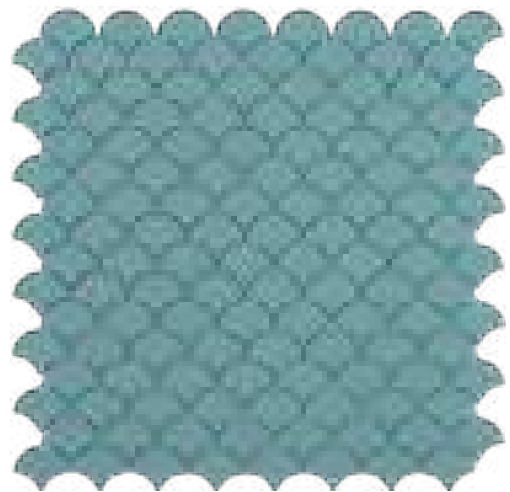

6101 SOUL TURQUOISE MT

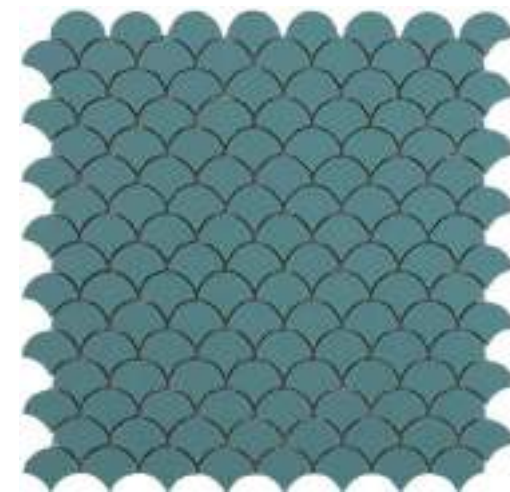

6107 SOUL GREEN MT



6104 SOUL BLUE MT

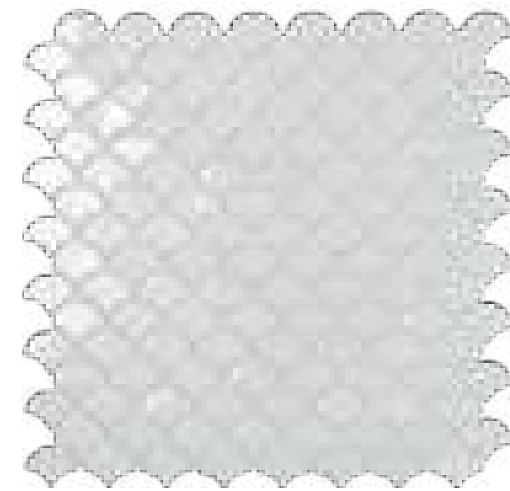

6000 SOUL WHITE BR



6005 SOUL BLACK BR

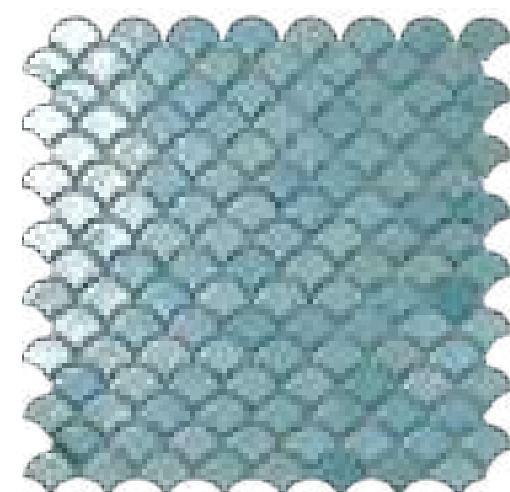

6001 SOUL TURQUOISE BR

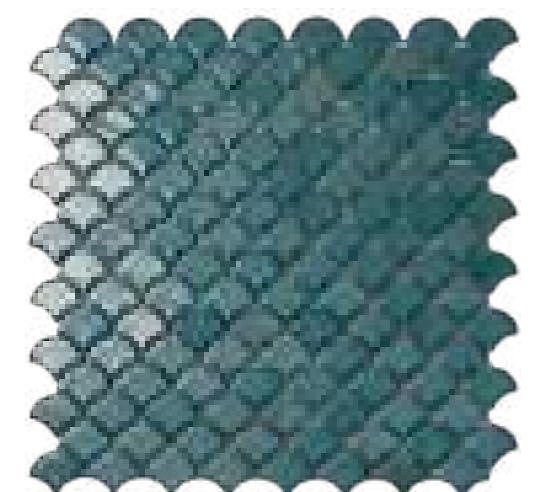

6003 SOUL GREEN BR

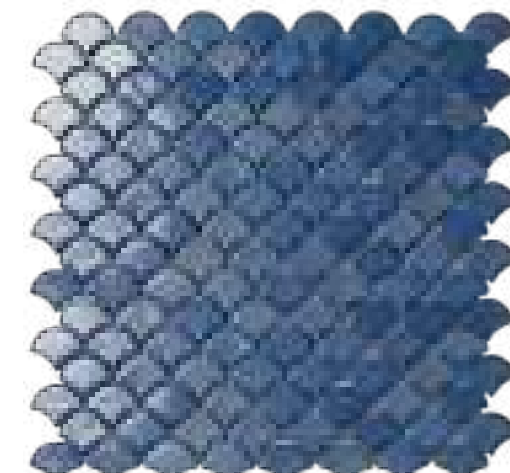

6004 SOUL DARK BLUE BR

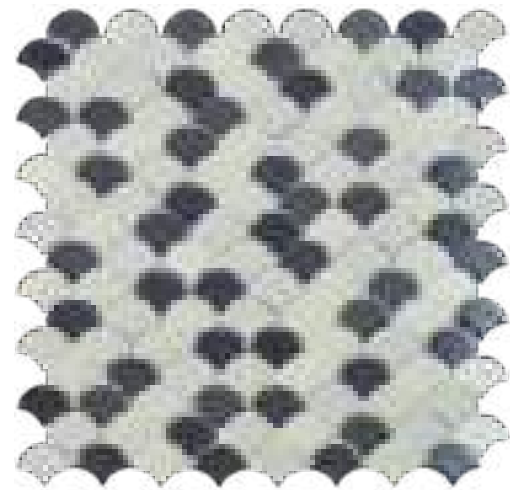

SOUL BLACK MIX

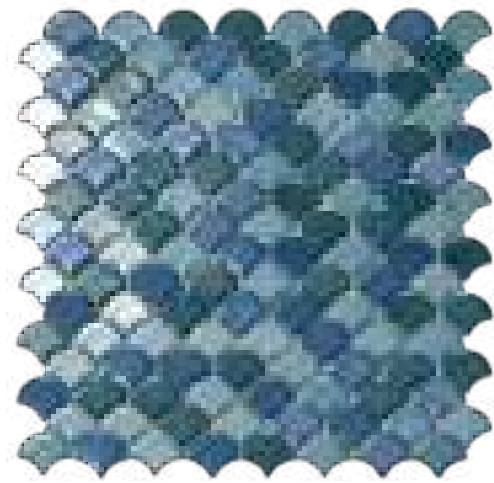

SOUL GREEN MIX

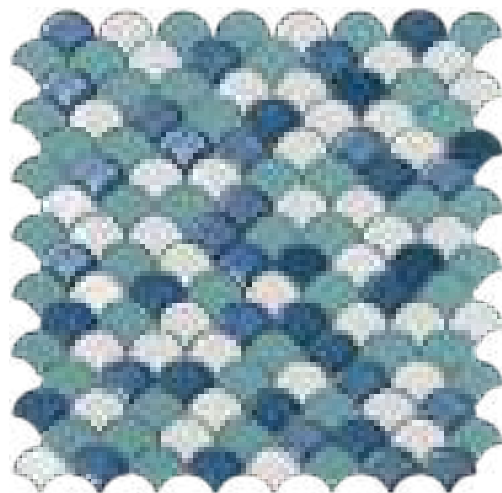

SOUL BLUE MIX

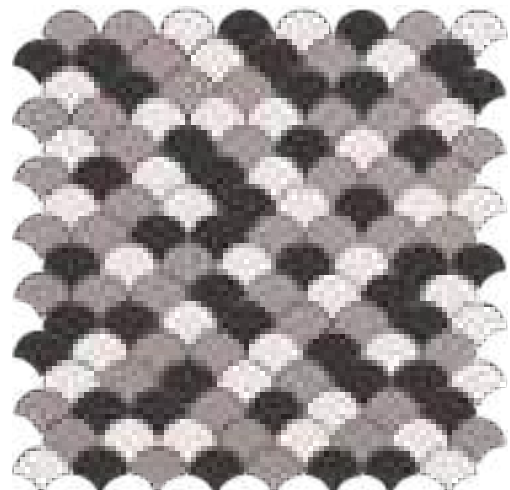

SOUL FRAPPE MIX

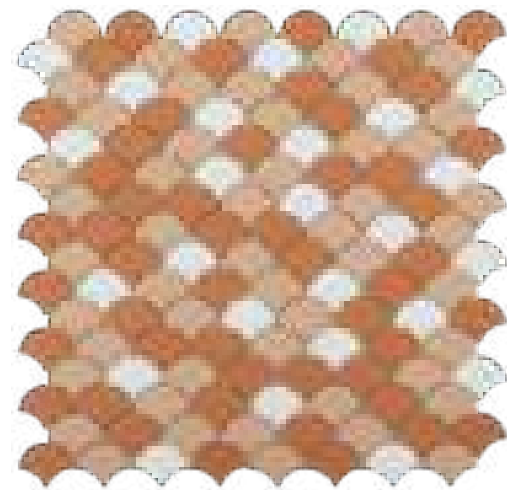

SOUL COTTO MIX



SOUL COTTO MIX

FORMATO - SIZE	PLACA SHEET PLAQUE			CAJA BOX CAISSE			PALET PALLET PALETTE		
	PIEZAS PIECES	MEDIDA DIMENSIONS	KGS KGS	PLACAS SHEET	M ² SQM	KGS KGS	CAJAS BOXES	M ² SQM	KGS KGS
36x29 MM	128	324x317	0,99	10	0,87	9,93	126	109,62	1.251,18
36x29 MM ORNAMENTAL	112	294x325	0,708	10	0,82	7,08	126	103,32	892,08

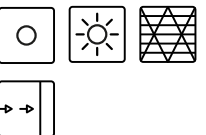



COMPOSICIÓN SOUL ORNAMENTAL

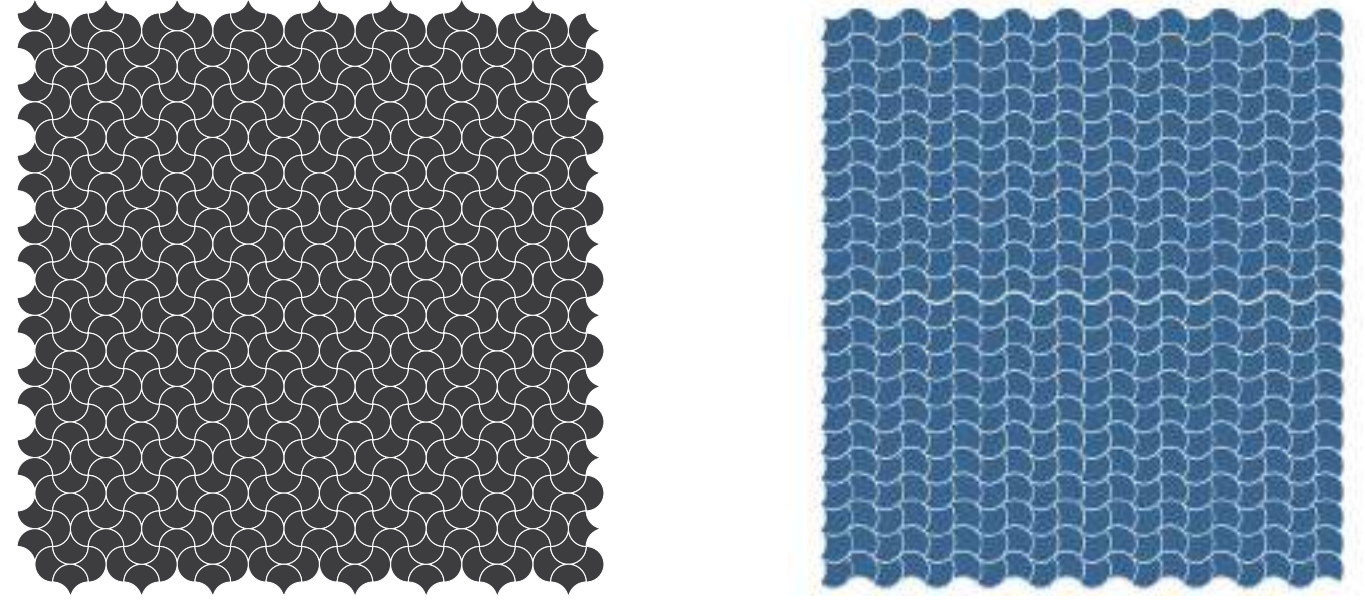
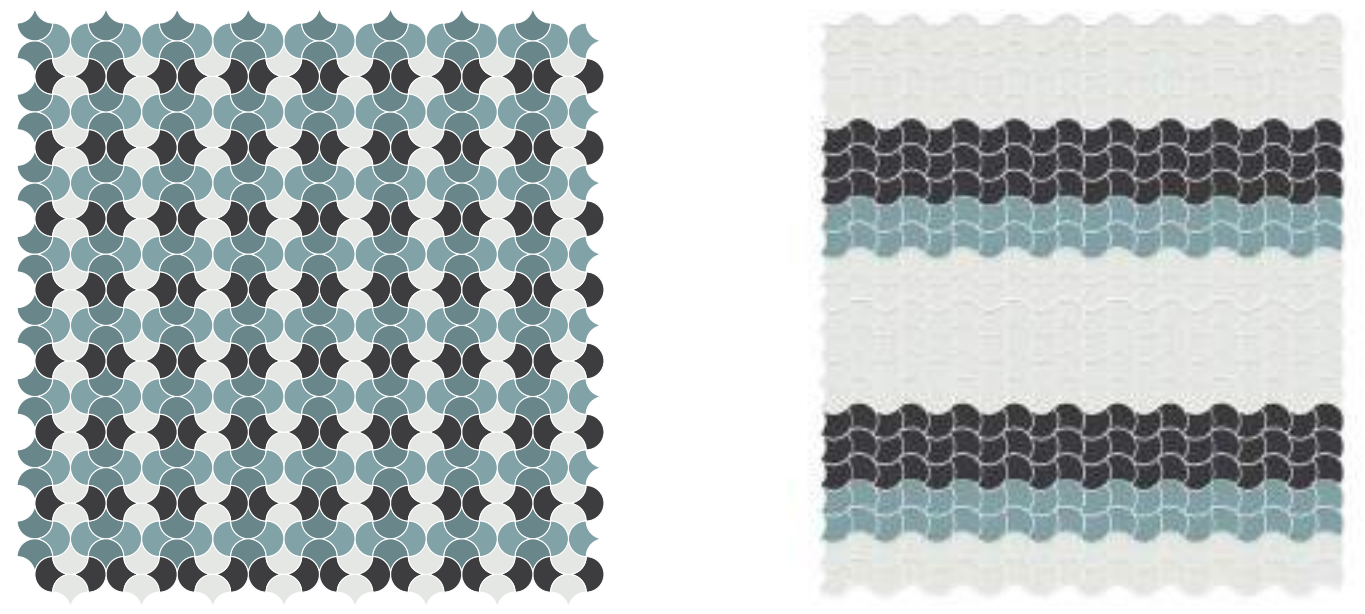
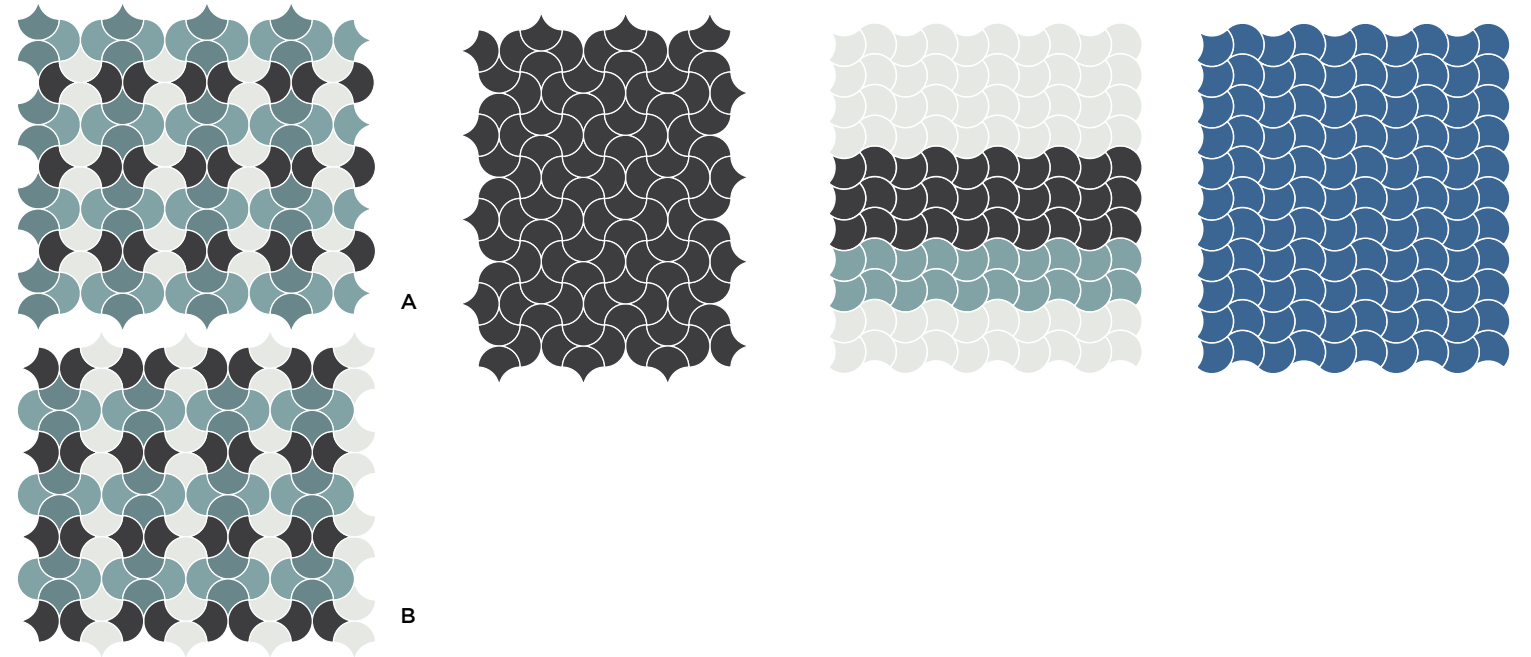

COMPOSICIÓN SOUL ORNAMENTAL

COMPOSICIÓN SOUL ONDAS



62

910 NORDIC WHITE MT HEX



NORDIC COLLECTION

Colores neutros, actuales y texturas suaves. Símbolo de sobriedad, elegancia, nos transmiten una sensación de armonía.

Los básicos como los colores de la naturaleza, arena, marfil, beige, gris piedra, nos aportan relajación, tranquilidad y equilibrio, tonos versátiles y fáciles de combinar.

Modern, neutral colours and soft textures.

Basics such as the colours of nature, sand, ivory, beige and stone grey transmit a sense of relaxation, tranquility and balance. Versatile tones easily combined.

Couleurs neutres, actuelles et textures suaves. Symbole de sobriété, élégance, nous transmettent une sensation d'harmonie.

Les fondamentales comme les couleurs de la nature, le sable, l'ivoire, le beige, le gris pierre, nous apportent détente, tranquillité et équilibre, tonalités versatiles, faciles à combiner.

63





64

910 NORDIC WHITE MT, 925 NORDIC LIGHT BLUE MT, 926 NORDIC FRAPPE MT, 903 NORDIC BLACK MT, 908 NORDIC DARK GREY MT



65

926 NORDIC FRAPPE MT HEX, 925/D NORDIC LIGHT BLUE MT HEX, 909 NORDIC LIGHT GREY MT HEX, 926/D NORDIC FRAPPE MT HEX, 925 NORDIC LIGHT BLUE MT HEX, 910/D NORDIC WHITE MT HEX





66

908 NORDIC DARK GREY MT HEX



67

910 NORDIC WHITE MT, 903/D NORDIC BLACK MT HEX





6106 NORDIC WHITE MT S

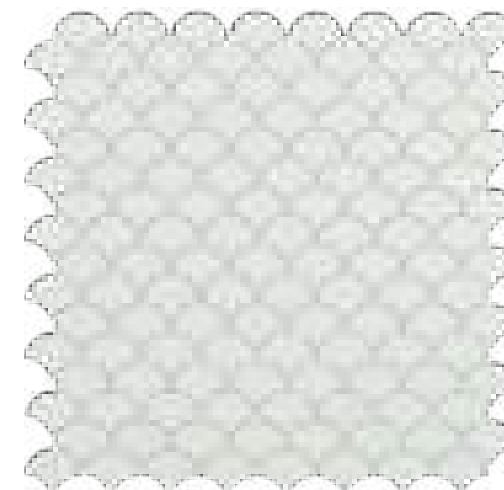

6106 NORDIC WHITE MT S

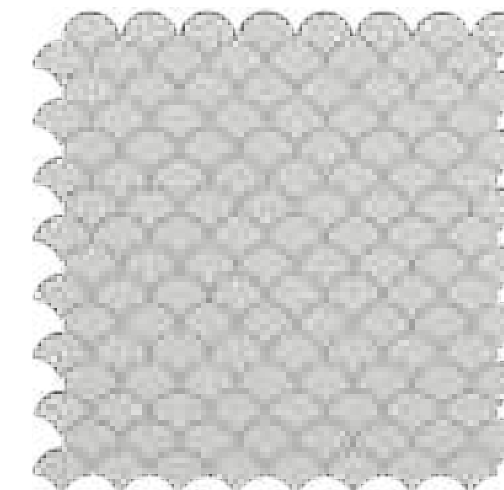

6110 NORDIC LIGHT GREY MT S



6105 NORDIC DARK GREY MT S



6108 NORDIC BLACK MT S

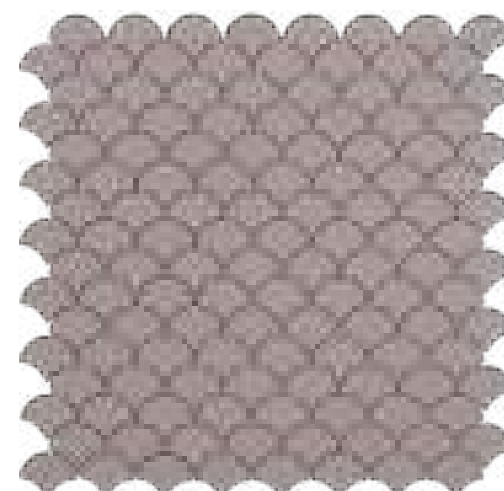

6100 NORDIC FRAPPE MT S

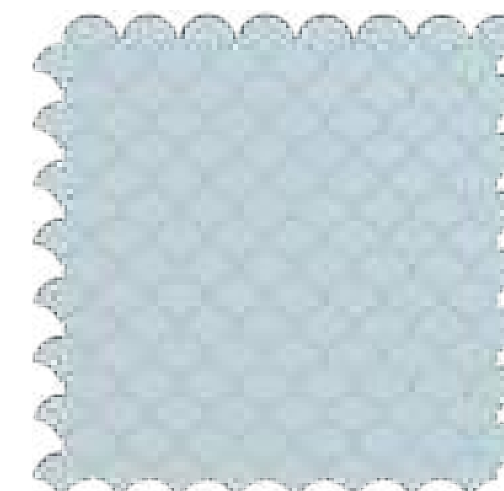

6109 NORDIC LIGHT BLUE MT S



903 NORDIC BLACK MT HEX

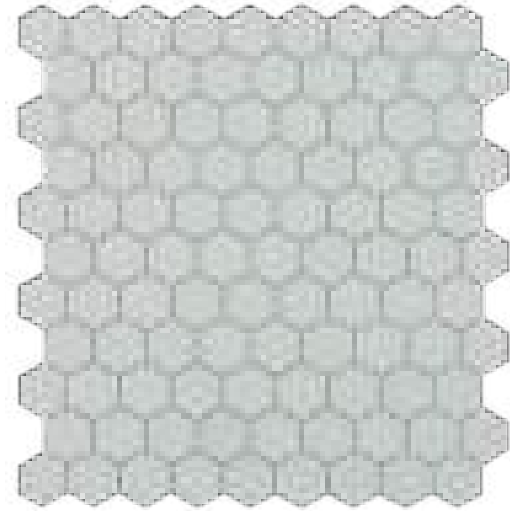

909 NORDIC LIGHT GREY MT HEX



908 NORDIC DARK GREY MT HEX

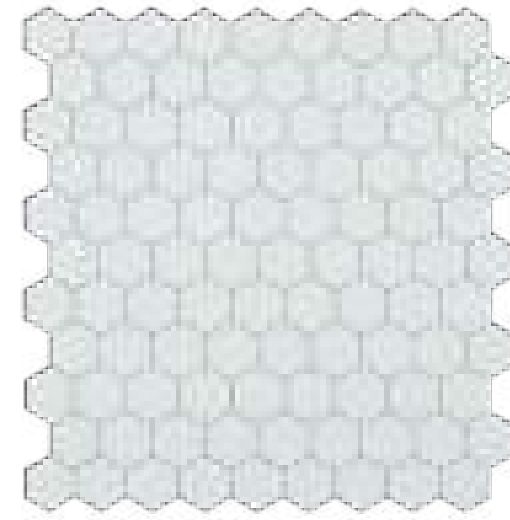

910 NORDIC WHITE MT HEX

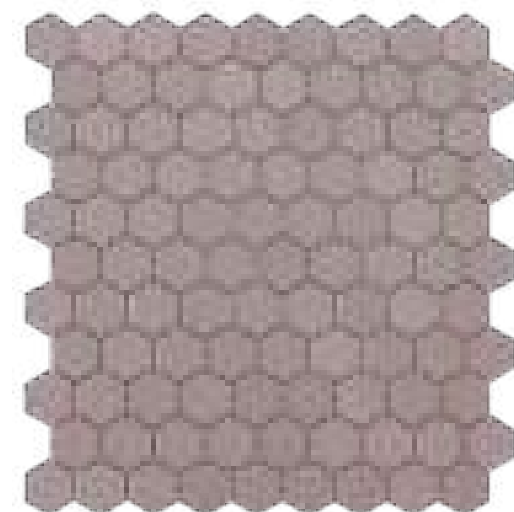

926 NORDIC FRAPPE MT HEX

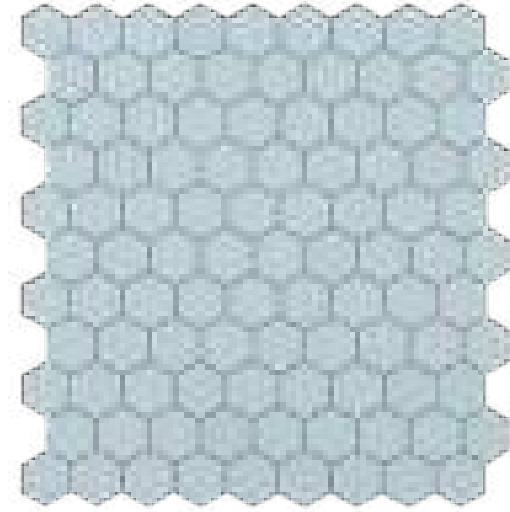

925 NORDIC LIGHT BLUE MT HEX

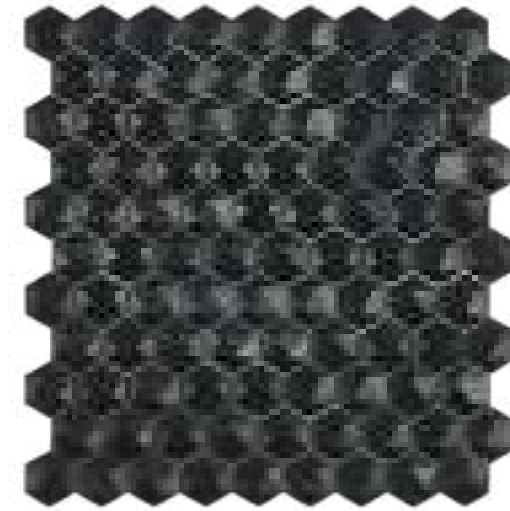

903/D NORDIC BLACK MT HEX

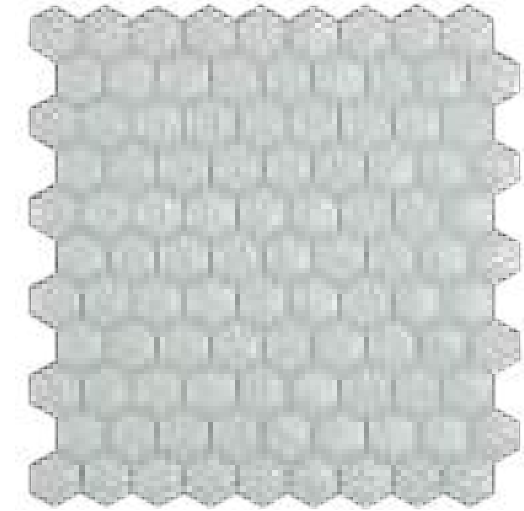

909/D NORDIC LIGHT GREY MT HEX

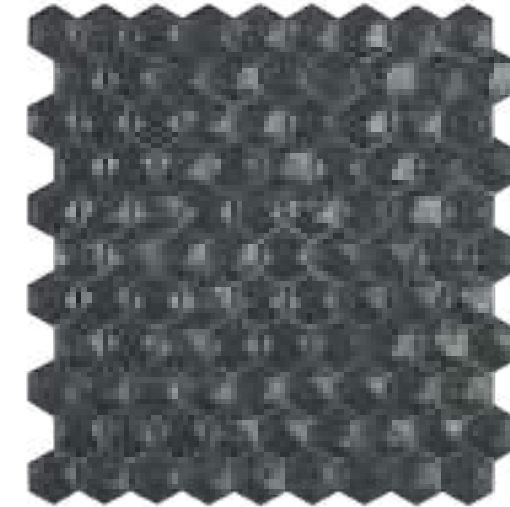

908/D NORDIC DARK GREY MT HEX



910/D NORDIC WHITE MT HEX

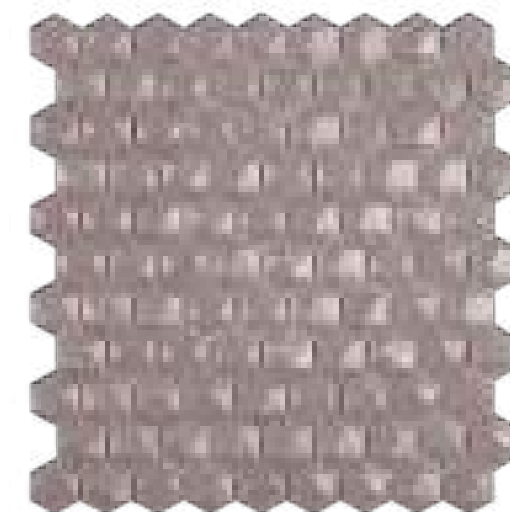

926/D NORDIC FRAPPE MT HEX

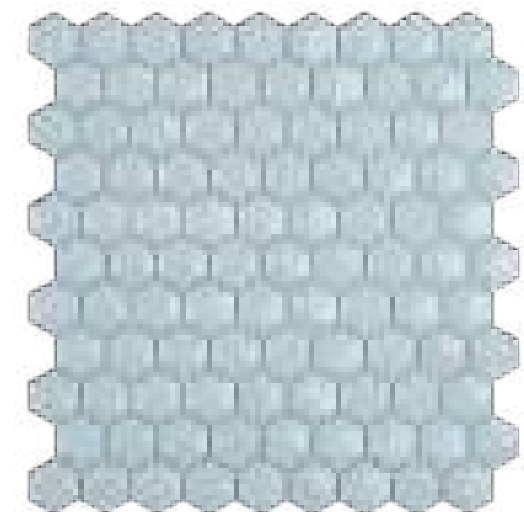

925/D NORDIC LIGHT BLUE MT HEX



910 NORDIC WHITE MT, 926 NORDIC FRAPPE MT

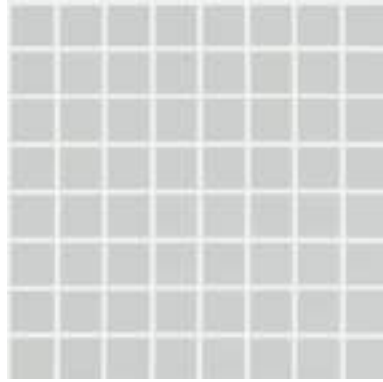

909 NORDIC LIGHT GREY MT



910 NORDIC WHITE MT



908 NORDIC DARK GREY MT

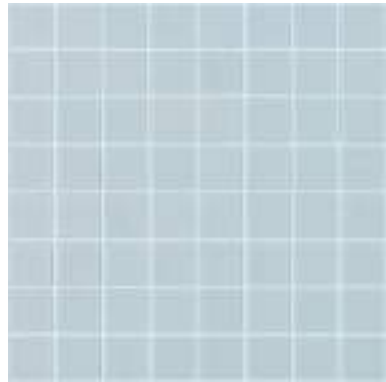

925 NORDIC LIGHT BLUE MT



903 NORDIC BLACK MT

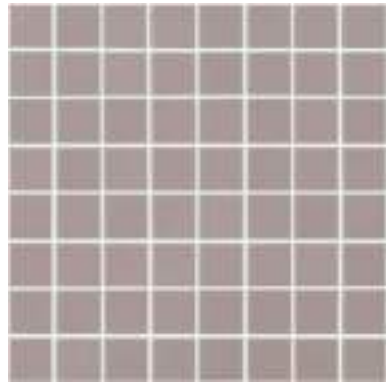

926 NORDIC FRAPPE MT



74

925 NORDIC LIGHT BLUE MT

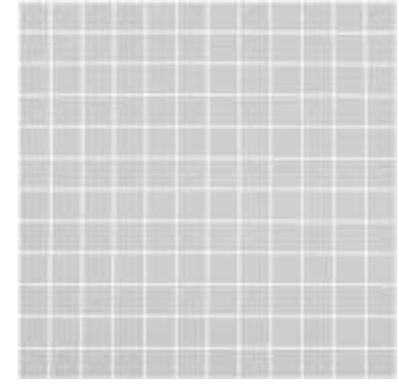

909 NORDIC LIGHT GREY MT

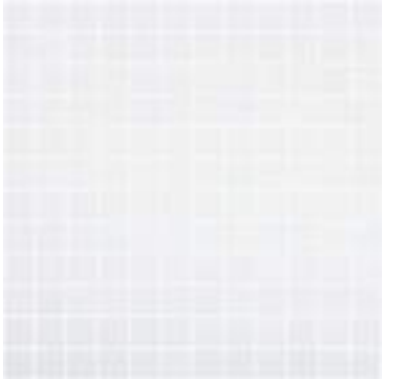

910 NORDIC WHITE MT



908 NORDIC DARK GREY MT

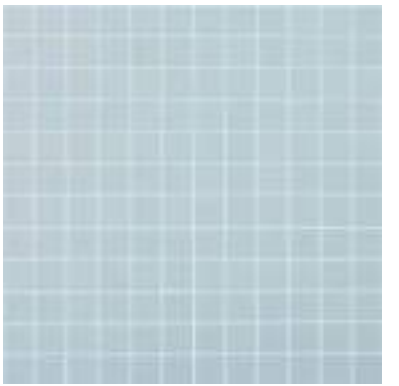

925 NORDIC LIGHT BLUE MT



903 NORDIC BLACK MT

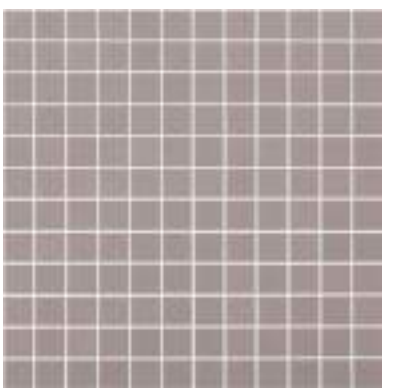

926 NORDIC FRAPPE MT

75

FORMATO - SIZE	PLACA SHEET PLAQUE			CAJA BOX CAISSE			PALET PALLET PALETTE		
	PIEZAS PIECES	MEDIDA DIMENSIONS	KGS KGS	PLACAS SHEET	M ² SQM	KGS KGS	CAJAS BOXES	M ² SQM	KGS KGS
25x25 MM	144	315x315	0,90	20	2	18	63	126	1.134,00
35x35 MM	99	317x307	0,99	10	0,87	9,93	126	109,62	1.251,18
35x35 MM D	99	317x307	1,10	10	0,87	10,96	126	109,62	1.380,96
36x29 MM S	128	324x317	0,99	10	0,87	9,93	126	109,62	1.251,18
38x38 MM	64	315x315	1,040	20	2	21,166	63	126	1348,46

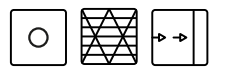

BEAUTY IN SIMPLICITY

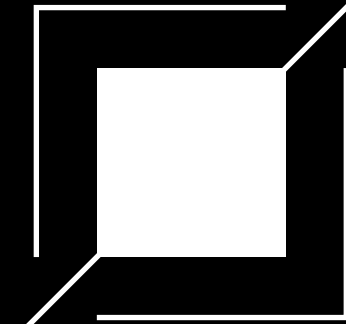



78

ANTARCTICA SNOW HEX



ANTARCTICA COLLECTION

Los colores neutros, blancos, mezclados con sofisticados acabados nacarados y marmoleados han dado paso a esta nueva colección de una versatilidad impresionante.

El blanco no es moda, es eterno, es una solución atractiva tanto para interiores en decoración como para zonas húmedas y además ahora tienes la opción de colocarlo como pavimento. Todo un acierto con esta nueva propuesta de Vidrepur.

Neutral, white colours combined with sophisticated pearl and marble finishings have opened the way for this new collection of impressive versatility.

White is not just a passing fashion, it is timeless, an attractive solution both for interior decoration and for damp areas. Now, you also have the option to lay it as paving. This new offer is a sure winner from Vidrepur.

Les couleurs neutres, blanches, combinées avec des finitions sophistiquées, nacrées et marbrées, ont donné lieu à cette nouvelle collection d'une polyvalence impressionnante.

Le blanc n'est pas une mode, il est éternel et représente une solution attrayante non seulement pour les espaces intérieurs mais aussi pour les zones humides. Vous avez désormais l'option de l'utiliser dans vos revêtements. Cette nouvelle proposition de Vidrepur est une combinaison gagnante.

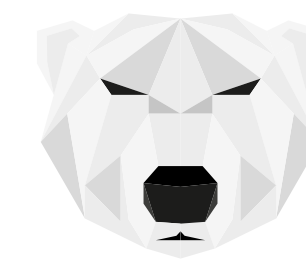

79



ANTARCTICA FROST



ANTARCTICA SNOW HEX

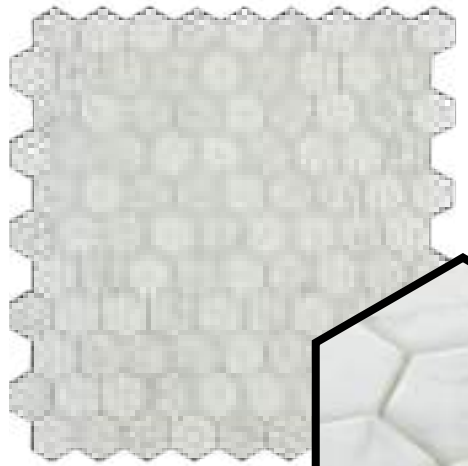

ANTARCTICA FLAKE HEX



ANTARCTICA FROST



ANTARCTICA POLAR



ANTARCTICA ASTRA WHITE



ANTARCTICA COLD

FORMATO - SIZE	PLACA SHEET PLAQUE			CAJA BOX CAISSE			PALET PALLET PALETTE		
	PIEZAS PIECES	MEDIDA DIMENSIONS	KGS KGS	PLACAS SHEET	M ² SQM	KGS KGS	CAJAS BOXES	M ² SQM	KGS KGS
25x25 MM	144	315x315	0,90	20	2	18	63	126	1.134,00
35x35 MM	99	317x307	0,99	10	0,87	9,93	126	109,62	1.251,18

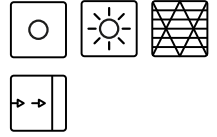



82

ELITE/D SAPELLY MIX HEX

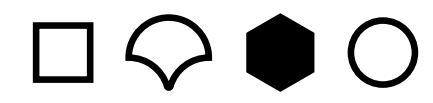

ELITE COLLECTION

Crea espacios únicos con nuestra colección Elite. Utiliza esta colección como zona preferente en tus ambientes, en tu hogar, baños proyectos y combina este increíble mosaico con todo tipo de materiales.

Create beautiful spaces with our Elite collection in special surfaces in your house, bathroom projects and combine these unique mosaics with all kind of materials.

Cree des espaces uniques avec notre collection Elite. Utilisez cette gamme sur des surfaces spéciales dans ta maison, salle de bain, projets et marie cette incroyable mosaïque avec tous types de matériaux.

83

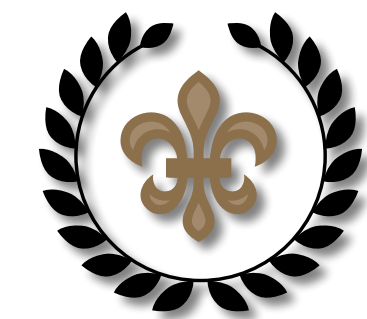



ELITE/D FOREST MIX HEX



ELITE/D FOREST MIX HEX

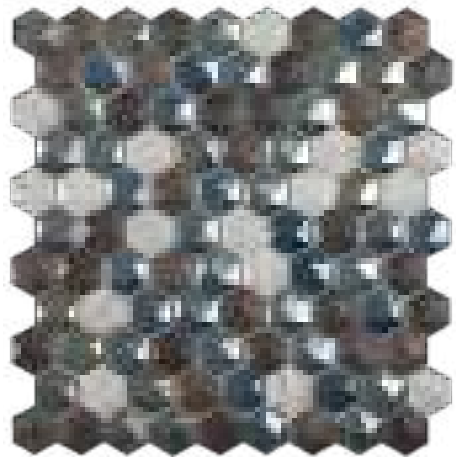

ELITE/D SAPELLY MIX HEX

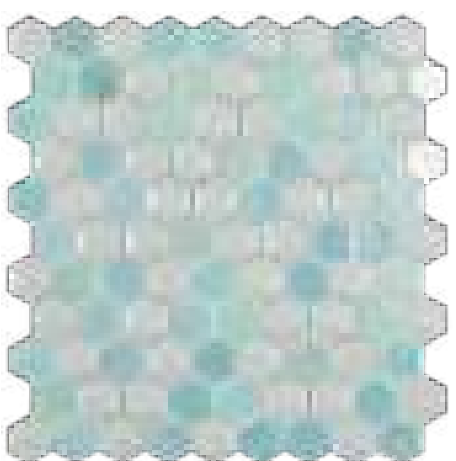

ELITE/D GLACIER MIX HEX



FORMATO - SIZE	PLACA SHEET PLAQUE			CAJA BOX CAISSE			PALET PALLET PALETTE		
	PIEZAS PIECES	MEDIDA DIMENSIONS	KGS KGS	PLACAS SHEET	M ² SQM	KGS KGS	CAJAS BOXES	M ² SQM	KGS KGS
35x35 MM	99	317x307	1,10	10	0,87	10,96	126	109,62	1.380,65

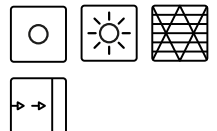

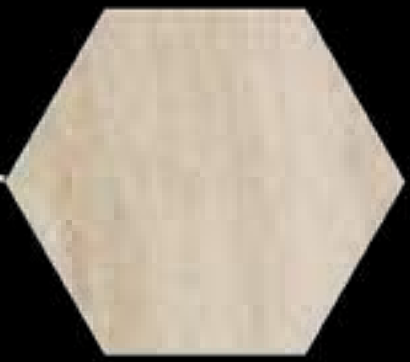
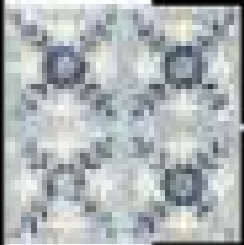

NATURE INSPIRATIONS

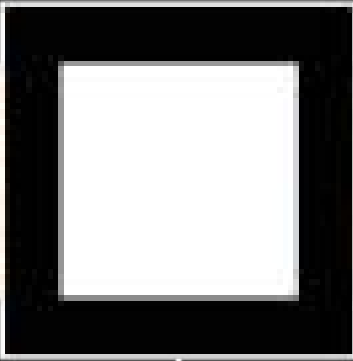
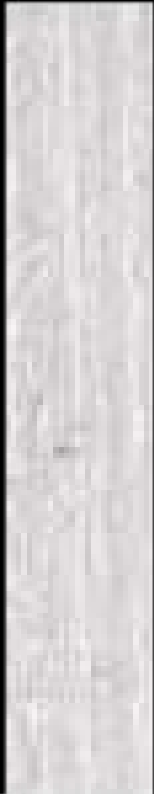
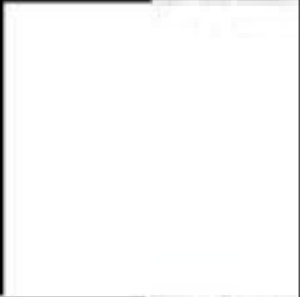



WOODS COLLECTION

La naturaleza es inspiración para Vidrepur. La creación de estas maderas naturales y la posibilidad que brinda su variación en relieve o liso, hace de esta colección un imprescindible para el punto de venta. Tanto por si solas, o como decoración para revestimientos en baños y cocinas junto a otros materiales, estas maderas son fruto del diseño y tecnología de una firma preocupada por ofrecer las mejores soluciones.

Nature is an inspiration for Vidrepur. The creation of these natural woods and the possibilities offered by their embossed and smooth variations, make this an essential collection for the point of sale. Both on their own, or as decoration for coatings in bathrooms and kitchens with other materials, these woods are the result of design and technology by a firm insistent on providing the best solutions.

Vidrepur s'inspire de la nature. Cette collection à base de bois naturels déclinés en relief ou lisse, c'est un must-have du point de vente. À eux seuls ou comme décoration pour les revêtements de salles de bains et cuisines combinés à d'autres matériaux, ces bois sont le fruit du design et de la technologie d'une griffe soucieuse d'offrir les meilleures solutions.





90

4202/B EDNA WOOD FRESNO MT

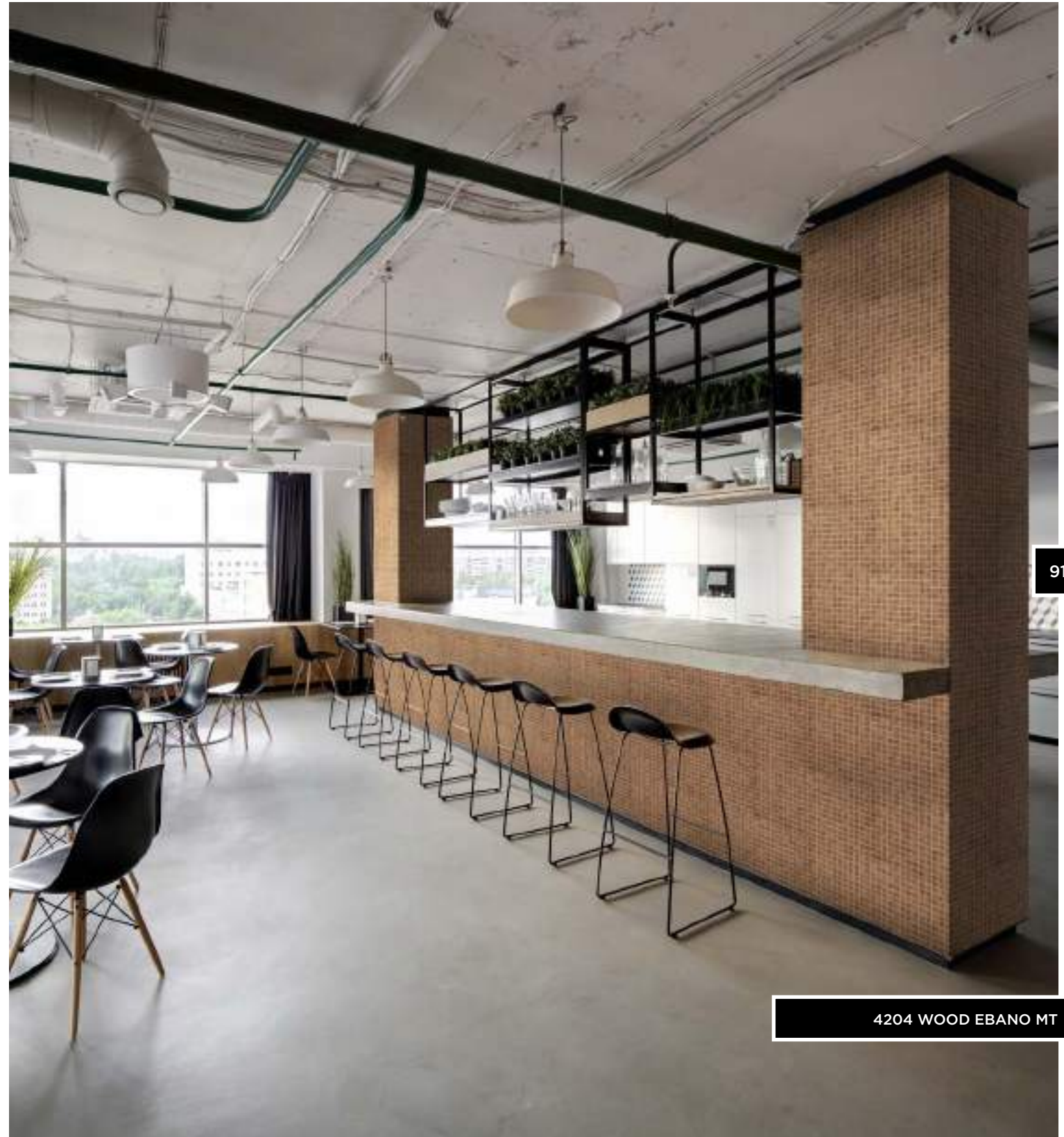

91

4204 WOOD EBANO MT



4202 WOOD FRESNO MT

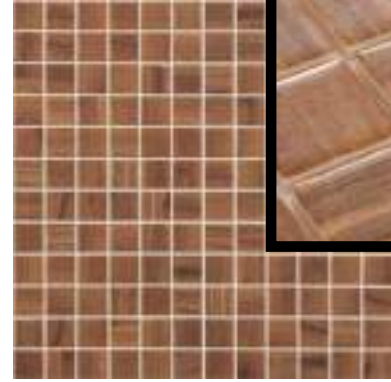

4200 WOOD NOGAL MT

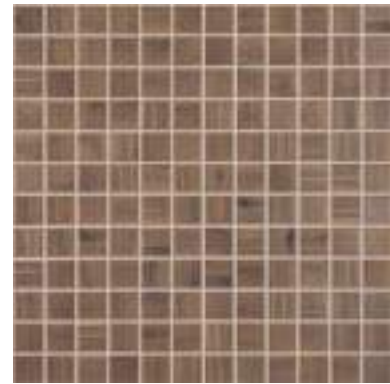

4204 WOOD ÉBANO MT



4201 WOOD CEREZO MT

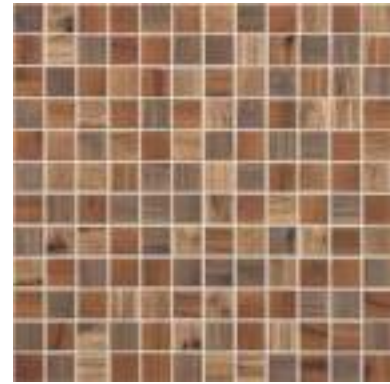

WOOD DARK BLEND MT



WOOD BLEND MT



WOOD ETHNIC FRESNO MT



WOOD ETHNIC CEREZO MT

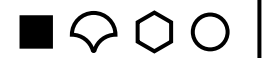

4202/B EDNA WOOD FRESNO MT

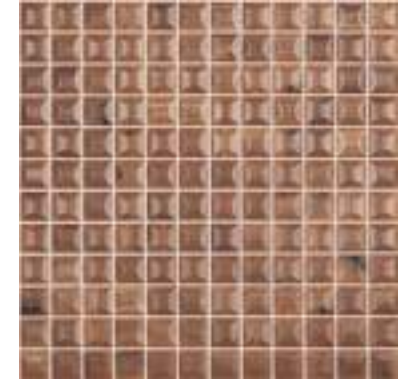

4200/B EDNA WOOD NOGAL MT

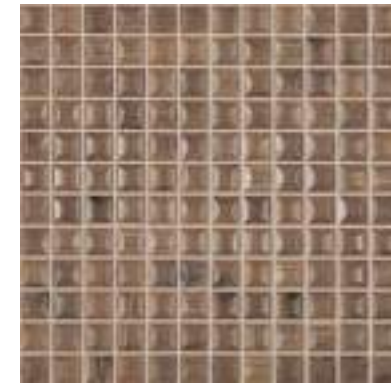

4204/B EDNA WOOD ÉBANO MT



4201/B EDNA WOOD CEREZO MT



EDNA WOOD DARK BLEND MT



EDNA WOOD BLEND MT



94

4700 ROYAL LIGHT HEX



4700 ROYAL LIGHT HEX

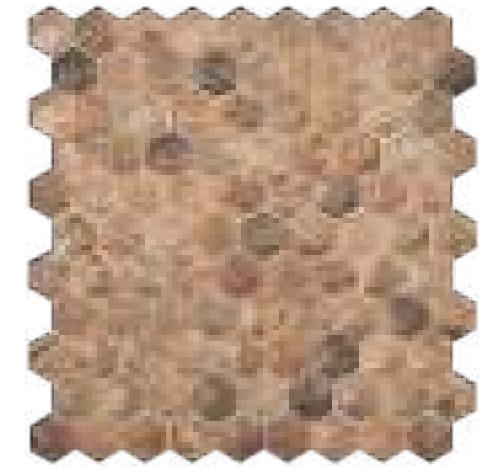

4700/D ROYAL LIGHT HEX

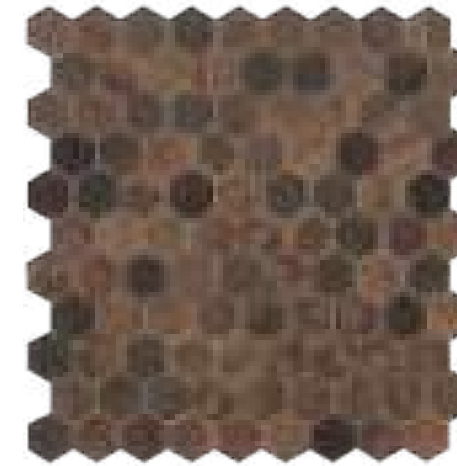

4701 ROYAL DARK HEX *

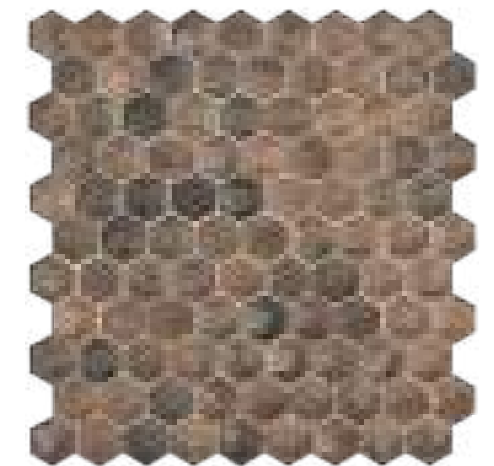

4701/D ROYAL DARK HEX

95



* REFERENCIAS DISPONIBLES EN ACABADO ANTIDESLIZANTE
* AVAILABLE REFERENCES IN ANTISLIP FINISHED
* RÉFÉRENCES DISPONIBLES EN FINITIONS ANTIDÉRAPANTES





96

4219 LEGEND FUNGI HEX



4216 LEGEND ANGORA HEX



4217 LEGEND VAPOR BLUE HEX



4219 LEGEND FUNGI HEX



4218 LEGEND PALOMA HEX



97

FORMATO - SIZE	PLACA SHEET PLAQUE			CAJA BOX CAISSE			PALET PALLET PALETTE		
	PIEZAS PIECES	MEDIDA DIMENSIONS	KGS KGS	PLACAS SHEET	M ² SQM	KGS KGS	CAJAS BOXES	M ² SQM	KGS KGS
35x35 MM	99	317x307	0,99	10	0,87	9,93	126	109,62	1.251,18
25x25 MM	144	315x315	0,90	10	1	9	126	126	1.134,00
25x25 MM EDNA	144	315x315	1,05	10	1	10,05	126	126	1.323,00

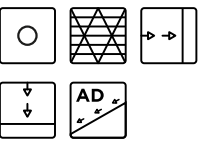



STONES COLLECTION

Inspirado en el travertino natural, esta colección de mosaico vítreo refleja el acabado y volumen perfecto para reproducir fielmente y de forma natural este tipo de piedra, ahora más de moda que nunca. La experiencia, el saber y las nuevas tecnologías se unen para obtener un producto de un valor añadido excepcional y un diseño demandado para uso del hogar, piscinas, comercial, etc.

Los tres tonos de la colección inspirados en las tonalidades natural, beige y nogue, en un acabado satinado y agradable al tacto, incorporan un valor adicional al mosaico vítreo de Vidrepur.

Inspired by natural travertine, this collection of glass mosaic reflects the perfect volume and finish to accurately and naturally reproduce this type of stone, now more fashionable than ever. Experience, knowledge and new technology come together to obtain a product of exceptional added value and sought after design for use in the home, swimming pools, businesses and more.

The three colors in the collection, inspired by off white, beige and walnut tones, with a satin finish that is pleasant to the touch, bring additional value to Vidrepur's glass mosaic.

Inspirée du travertin naturel, cette collection de mosaïque en verre révèle la finition et le volume parfaits pour reproduire fidèlement et naturellement ce type de roche, plus en vogue que jamais. L'expérience, la connaissance et les nouvelles technologies s'unissent pour obtenir un produit à valeur ajoutée exceptionnelle et une conception réclamée pour être utilisée dans les foyers, piscines, commerces, etc.

Les trois tonalités de la collection inspirées des tons nature, beige et noce et une finition satinée et agréable au toucher, apportent une valeur supplémentaire à la mosaïque en verre de Vidrepur.



100

4102 TRAVERTINO BONE MT



101





EDNA TRAVERTINO BLEND MT, 4102/B EDNA TRAVERTINO BONE MT



TRAVERTINO BLEND MT

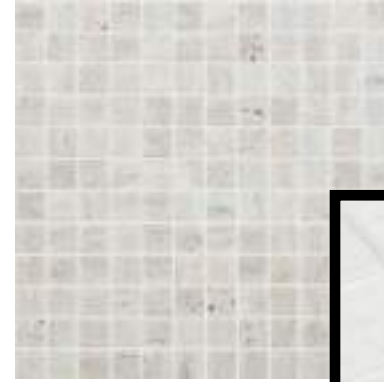

4102 TRAVERTINO BONE MT



4101 TRAVERTINO BEIGE MT



4100 TRAVERTINO NOCE MT



EDNA TRAVERTINO BLEND MT



4102/B EDNA TRAVERTINO BONE MT

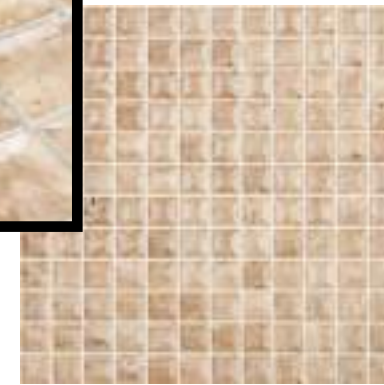

4101/B EDNA TRAVERTINO BEIGE MT



4100/B EDNA TRAVERTINO NOCE MT

FORMATO - SIZE	PLACA SHEET PLAQUE			CAJA BOX CAISSE			PALET PALLET PALETTE		
	PIEZAS PIECES	MEDIDA DIMENSIONS	KGS KGS	PLACAS SHEET	M ² SQM	KGS KGS	CAJAS BOXES	M ² SQM	KGS KGS
25x25 MM	144	315x315	0,90	10	1	9	126	126	1.134,00
25x25 MM EDNA	144	315x315	1,05	10	1	10,05	126	126	1.323,00

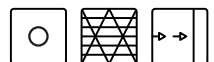

106



4703 TERRE BLUE HEX, 4706 TERRE BLUE DECOR HEX

107



4705 TERRE BEIGE DECOR HEX





108

4706 TERRE BLUE DECOR HEX, 908 NORDIC DARK GREY MT HEX, 910 NORDIC WHITE MT HEX

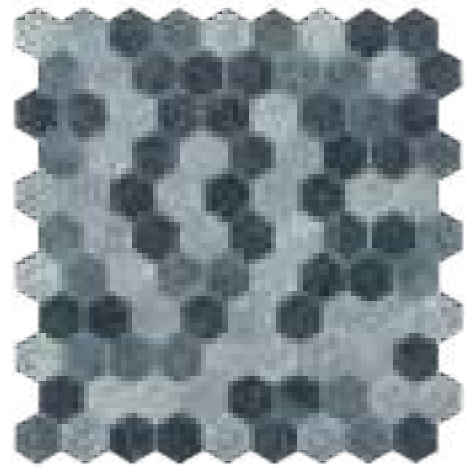

4703 TERRE BLUE HEX

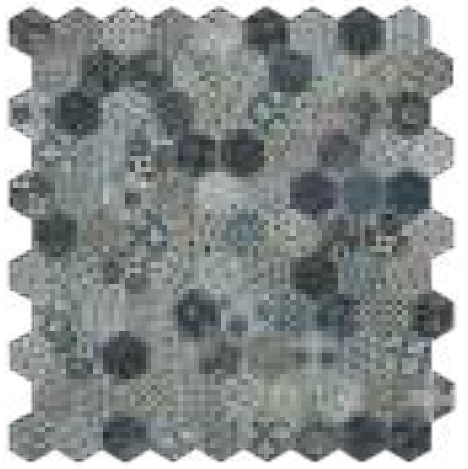

4706 TERRE BLUE DECOR HEX



4709 TERRE BEIGE HEX

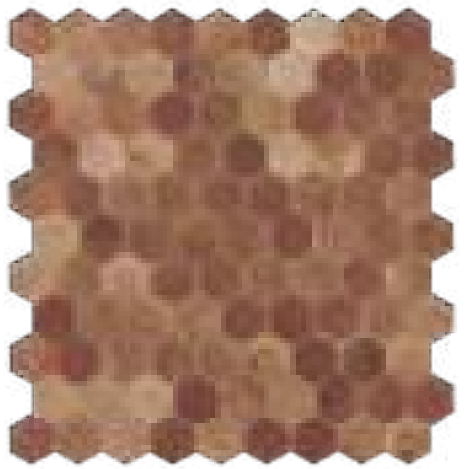

4702 TERRE COTTO HEX



4705 TERRE BEIGE DECOR HEX



109



110



111

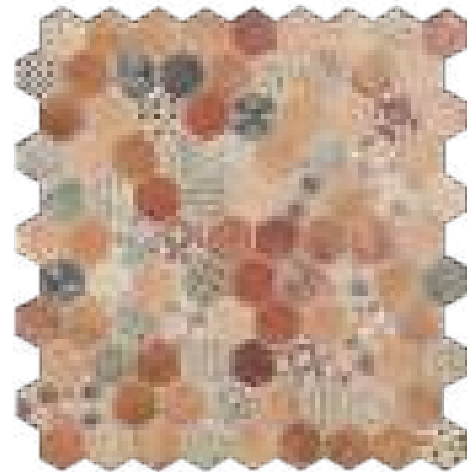

TERRE MIX BEIGE DECOR HEX

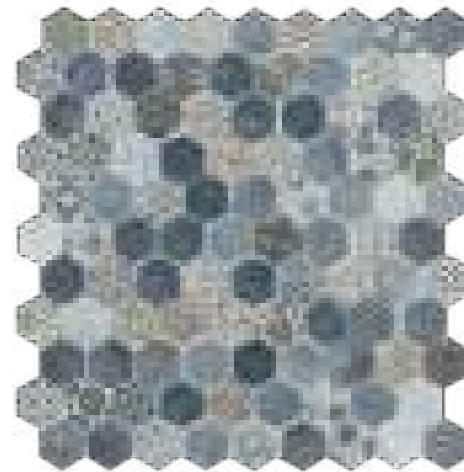

TERRE MIX BLUE DECOR HEX

TERRE MIX BLUE DECOR HEX

FORMATO - SIZE	PLACA SHEET PLAQUE			CAJA BOX CAISSE			PALET PALLET PALETTE		
	PIEZAS PIECES	MEDIDA DIMENSIONS	KGS KGS	PLACAS SHEET	M ² SQM	KGS KGS	CAJAS BOXES	M ² SQM	KGS KGS
35x35 MM	99	317x307	0,99	10	0,87	9,93	126	109,62	1.251,18

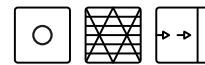



112

4222 DESERT BONE HEX



4222 DESERT BONE HEX



4223 DESERT CLOUD DANCER HEX



4224 DESERT PALOMA HEX



4225 DESERT STEEPLE GREY HEX

113



FORMATO - SIZE	PLACA SHEET PLAQUE			CAJA BOX CAISSE			PALET PALLET PALETTE		
	PIEZAS PIECES	MEDIDA DIMENSIONS	KGS KGS	PLACAS SHEET	M ² SQM	KGS KGS	CAJAS BOXES	M ² SQM	KGS KGS
35x35 MM	99	317x307	0,99	10	0,87	9,93	126	109,62	1.251,18

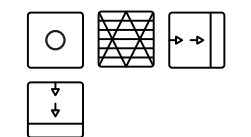



4221 SUPREME MARQUINA

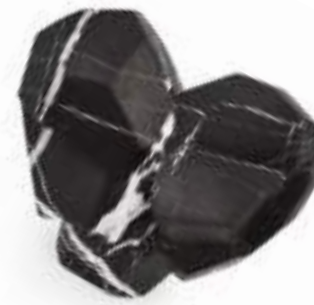

MARBLES COLLECTION

Los mármoles de siempre son ahora tendencia en el mundo de la decoración, incluso la moda. La selección de mármoles suaves, inspirados en el tradicional carrara y calacatta, en acabado brillo y satinado, abre un mundo de posibilidades ahora con el mosaico de vidrepur.

No solo pueden decorar y revestir cualquier espacio del hogar, sino que también otorgan armonía y distinción a piscinas y zonas húmedas, donde ya se han utilizado este tipo de productos nobles en grandes proyectos, y que ahora son protagonistas de un nuevo estilo.

Traditionally used marble has now become a trend in the world of decoration and even fashion. This selection of soft marble, inspired by traditional calacatta and carrara, with a gloss and satin finish, now opens up a world of possibilities with vidrepur's mosaics.

As well as being used to decorate and coat any room in the home, they also give harmony and distinction to pools and bathrooms, where these type of noble products have already been used in large projects, and are now the focal point of a new style.

Les marbres de toujours sont aujourd'hui tendance dans le monde de la décoration et même une mode. La sélection de marbres doux, inspirés du carrata et du calacatta traditionnels, en finition brillante et satinée, ouvre désormais un monde de possibilités avec la mosaïque de vidrepur.

Ils décorent ou revêtent n'importe quel espace du foyer, mais aussi des piscines ou zones humides en leur conférant une harmonie et une touche de distinction. Ces matériaux nobles déjà utilisés dans de grands projets sont maintenant les vedettes d'un nouveau style.





4302/B EDNA CALACATTA MT

MARBLES COLLECTION | 25x25 MM | 1"x1" ■ 🔍 🏠



4302 CALACATTA MT



4302/B EDNA CALACATTA MT



5300 CARRARA GREY BR

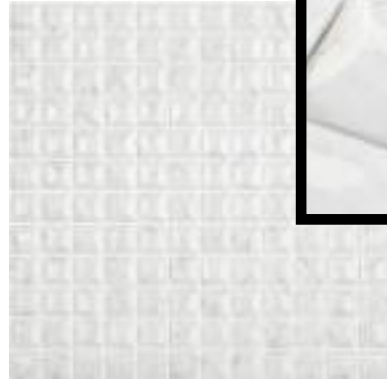

5300/B EDNA CARRARA GREY BR



4300 CARRARA GREY MT



4300/B EDNA CARRARA GREY MT



118

4300 CARRARA GREY MT HEX



119

4708 VIENA MT HEX



120

4300 CARRARA GREY MT HEX

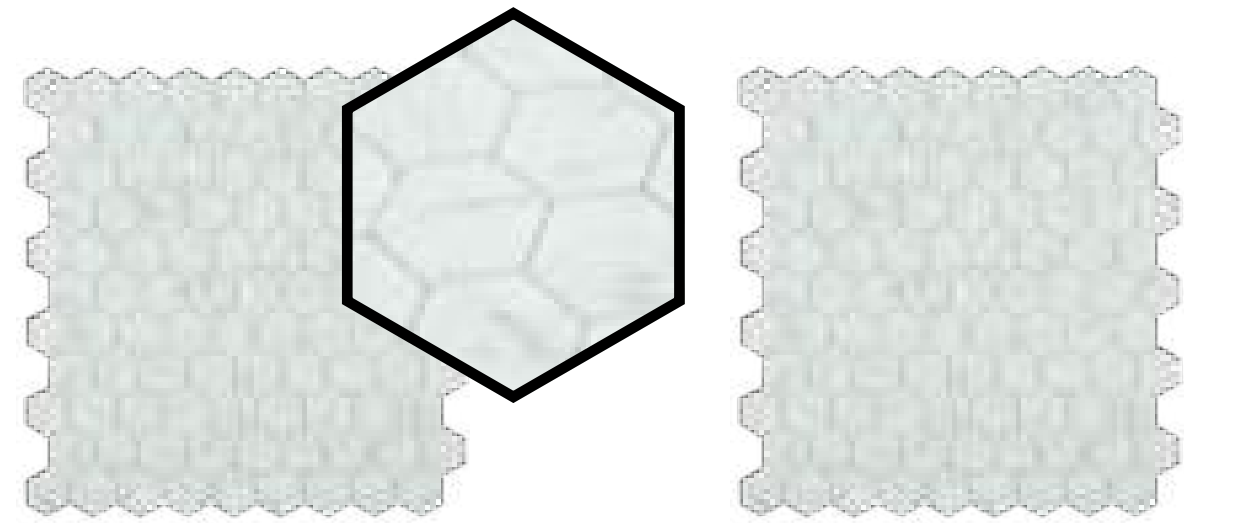

4300 CARRARA GREY MT HEX

4300 CARRARA GREY MT ANTID HEX

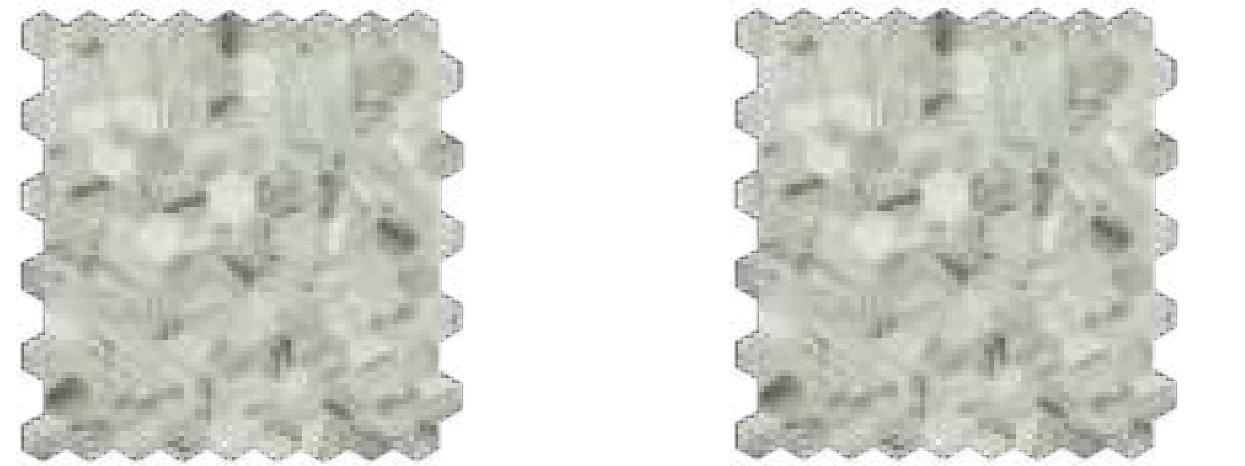

4708 VIENA MT HEX

4708 VIENA MT ANTID HEX



121

FORMATO - SIZE	PLACA SHEET PLAQUE			CAJA BOX CAISSE			PALET PALLET PALETTE		
	PIEZAS PIECES	MEDIDA DIMENSIONS	KGS KGS	PLACAS SHEET	M ² SQM	KGS KGS	CAJAS BOXES	M ² SQM	KGS KGS
35x35 MM	99	317x307	0,99	10	0,87	9,93	126	109,62	1.251,18
25x25 MM	144	315x315	0,90	10	1	9	126	126	1.134,00
25x25 MM EDNA	144	315x315	1,05	10	1	10,05	126	126	1.323,00

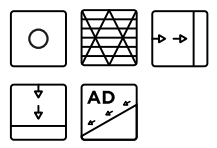

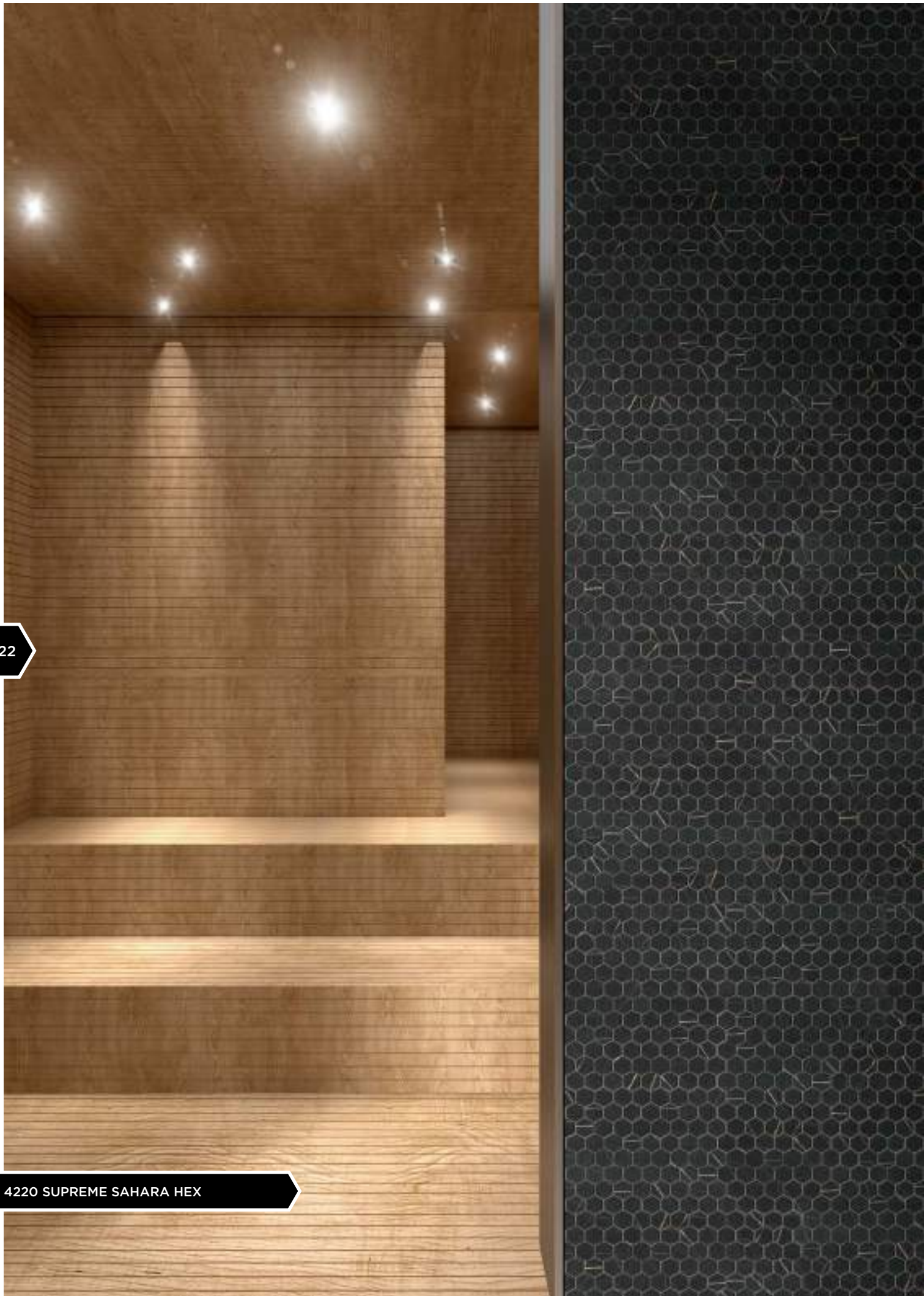

4220 SUPREME SAHARA HEX

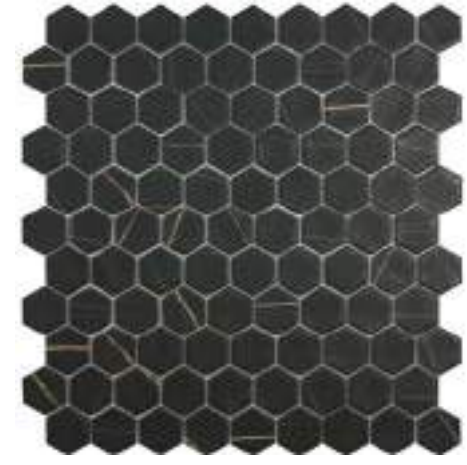

4220 SUPREME SAHARA HEX *

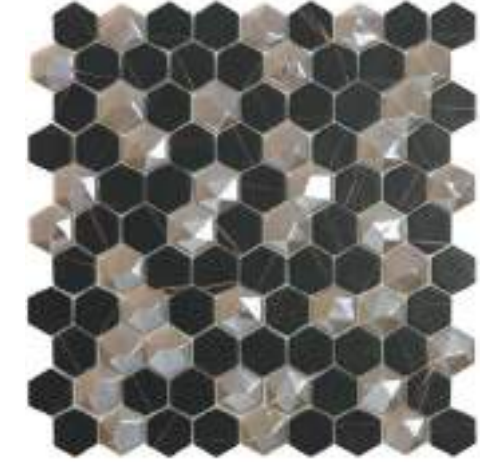

SAHARA MIX COFFEE HEX

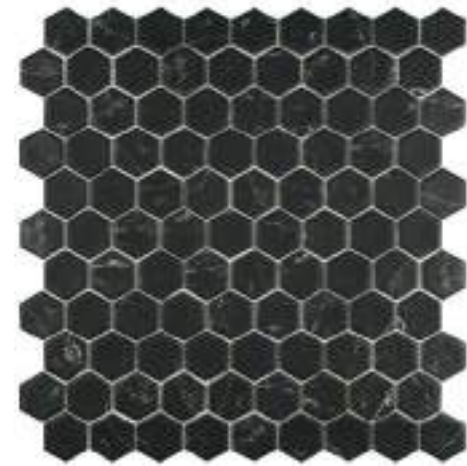

4221 SUPREME MARQUINA HEX *

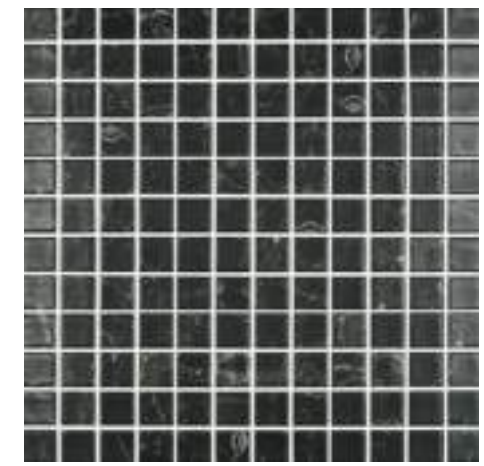

4221 SUPREME MARQUINA

* REFERENCIAS DISPONIBLES EN ACABADO ANTIDESLIZANTE
 * AVAILABLE REFERENCES IN ANTISLIP FINISHED
 * RÉFÉRENCES DISPONIBLES EN FINITIONS ANTIDÉRAPANTES



FORMATO - SIZE	PLACA SHEET PLAQUE			CAJA BOX CAISSE			PALET PALLET PALETTE		
	PIEZAS PIECES	MEDIDA DIMENSIONS	KGS KGS	PLACAS SHEET	M ² SQM	KGS KGS	CAJAS BOXES	M ² SQM	KGS KGS
25x25 MM	144	315x315	0,90	10	1	9	126	126	1.134,00
35x35 MM	99	317x307	0,99	10	0,87	9,93	126	109,62	1.251,18

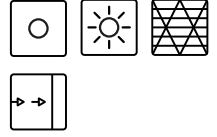

DECORATIVE INSPIRATIONS

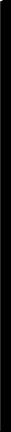
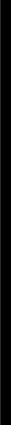
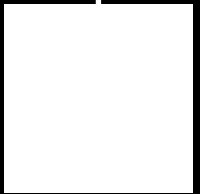
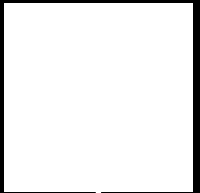
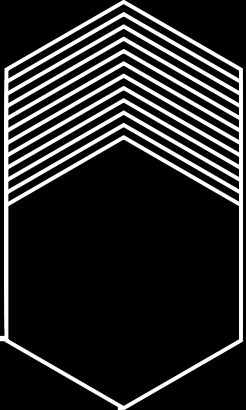
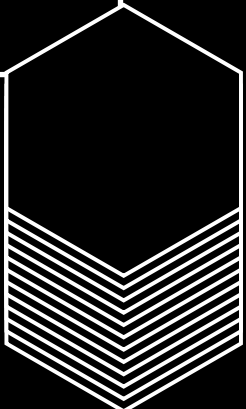
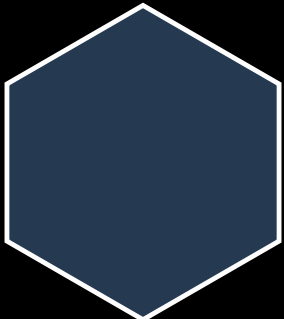
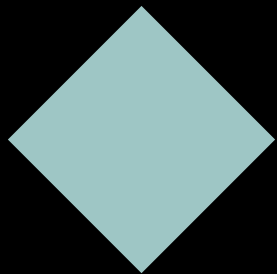
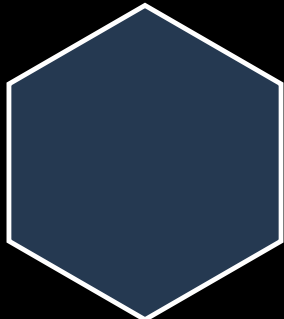



126

BORN GREY



BORN COLLECTION

El formato del mosaico vítreo, su textura suave, y sus múltiples usos, hacen que estas colecciones, pensadas para decorar de forma actual, ganen en presencia en el mundo del interiorismo.

Decoradores, diseñadores e interioristas, coinciden que el diseño unido a la tendencia en el uso del mosaico, permitirán que esta nueva colección de vidrepur, dentro del paraguas de impressions, impresione en cualquier uso en el que podamos soñar.

The format of the glass mosaic, its smooth texture and its many uses, all contribute to making these collections, designed for decorating in a current style, more widely used in the world of interior design.

Decorators, designers and interior designers all agree that design combined with the trend in the use of mosaic, will allow this new collection by vidrepur, under the impressions umbrella, to impress under any use that could be dreamt.

127



BORN BLUE

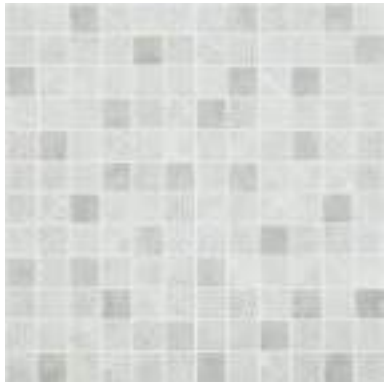

BORN GREY

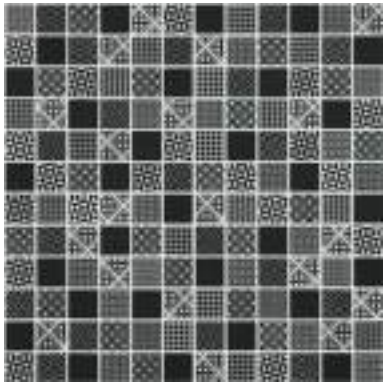

BORN BLACK



BORN BEIGE



BORN BROWN

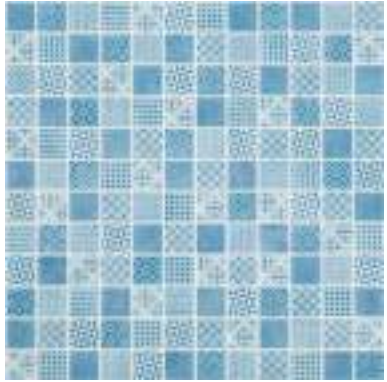

BORN BLUE

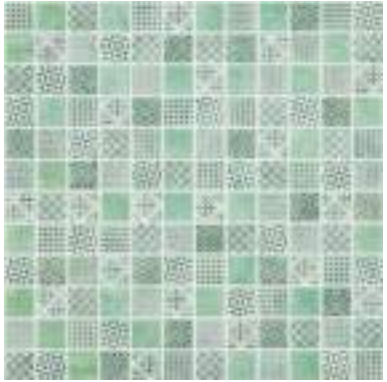

BORN GREEN

FORMATO - SIZE	PLACA SHEET PLAQUE			CAJA BOX CAISSE			PALET PALLET PALETTE		
	PIEZAS PIECES	MEDIDA DIMENSIONS	KGS KGS	PLACAS SHEET	M ² SQM	KGS KGS	CAJAS BOXES	M ² SQM	KGS KGS
25x25 MM	144	315x315	0,90	10	1	9	126	126	1.134,00

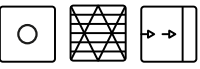



130



BIJOU WHITE



BIJOU COLLECTION

Con detalle y minuciosa artesanía, vidrepur lanza la nueva colección bijou, apostando por un formato de mosaico pequeño pero atractivo para decorar cualquier espacio.

La mezcla de texturas, brillos, y acabados satinados, realiza un juego de luces capaces de iluminar revestimientos de vanguardia.

Vidrepur has launched the new bijou collection, filled with detail and meticulous craftwork, opting for a mosaic format that is small yet attractive in decorating any space.

The combination of texture, shine and satin finishings creates a play of light and shadow able to illuminate avant-garde coatings.

Avec le soin et le travail détaillé des artisans vidrepur lance bijou, la nouvelle collection qui mise sur des mosaïques à petit format mais ravissants pour décorer n'importe quel espace.

Les textures, les brillants et les satinés se mélangent pour créer des jeux de lumière capables de faire rayonner les revêtements en vogue.



131



132

BIJOU COFFEE



BIJOU WHITE



BIJOU SATIN WHITE



BIJOU SILVER

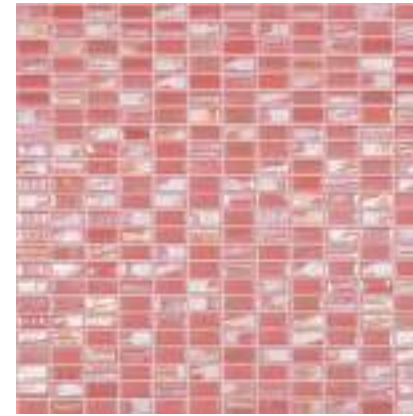

BIJOU SOFT RED

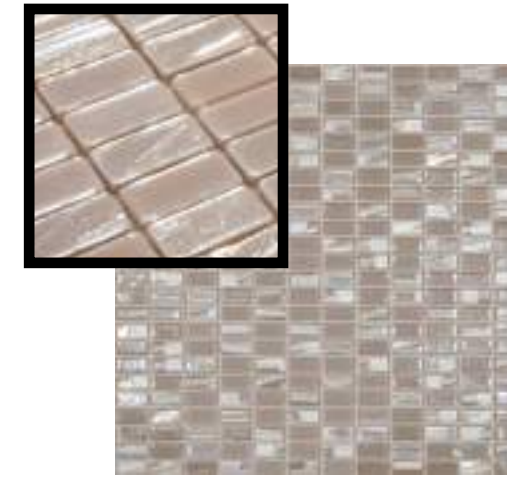

BIJOU COFFEE

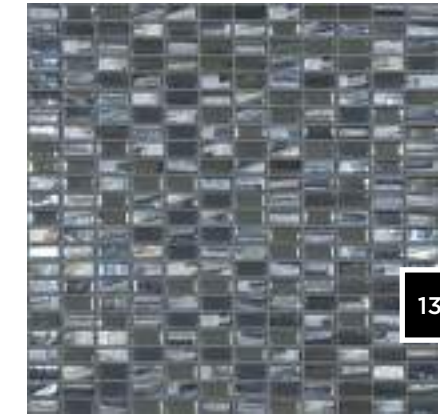

BIJOU BLACK

133



FORMATO - SIZE	PLACA SHEET PLAQUE			CAJA BOX CAISSE			PALET PALLET PALETTE		
	PIEZAS PIECES	MEDIDA DIMENSIONS	KGS KGS	PLACAS SHEET	M ² SQM	KGS KGS	CAJAS BOXES	M ² SQM	KGS KGS
25x12 MM	288	315x315	0,96	10	1	9,61	126	126	1.210,86

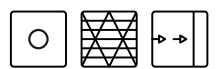



134

374/D DIAMOND RADIANT HEX

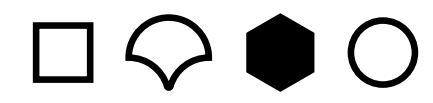

DIAMOND COLLECTION

La luz que proyecta la colección diamond y el relieve de la misma, hacen de esta colección una línea de producto de mucho valor añadido, colores atractivos, brillo y lustre, unido para crear espacios sofisticados y diferentes.

The light given off by the diamond collection and the surface texture of the same mean that this collection offers products with added value, attractive colours and a bright and glossy finish, which come together to create unique, sophisticated spaces.

La lumière projetée par la collection diamond et le relief donné à celle-ci en font une ligne de produit à grande valeur ajoutée ; des couleurs somptueuses, son opalescence et son éclat s'unissent pour créer des espaces sophistiqués et singuliers.

135



136

370/D DIAMOND TURQUESA HEX

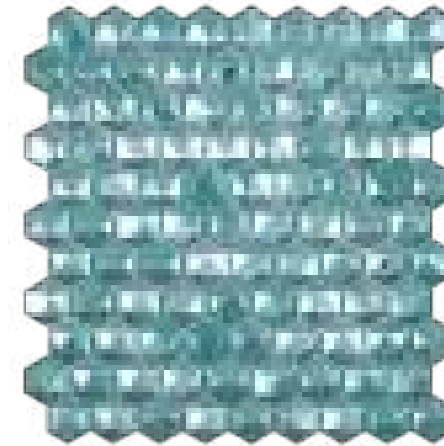

370/D DIAMOND TURQUESA HEX

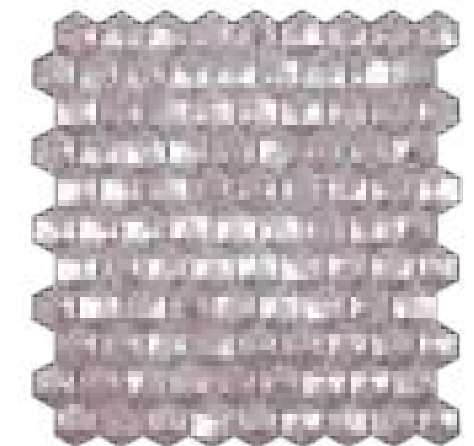

371/D DIAMOND NOSTALGIC HEX

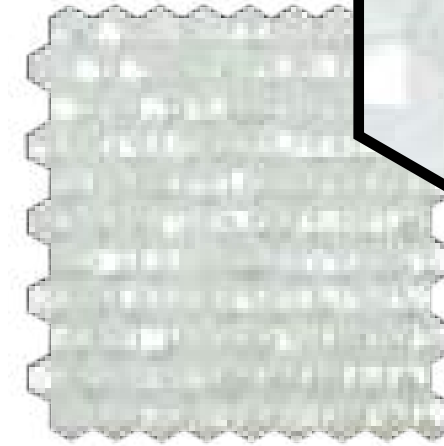

350/D DIAMOND WHITE HEX

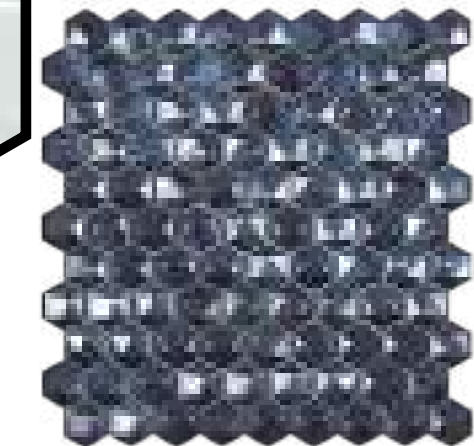

374/D DIAMOND RADIANT HEX

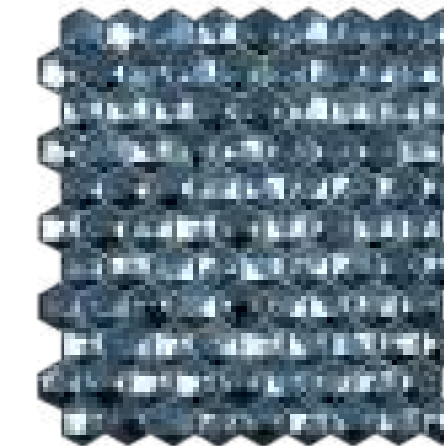

358/D DIAMOND BLACK HEX

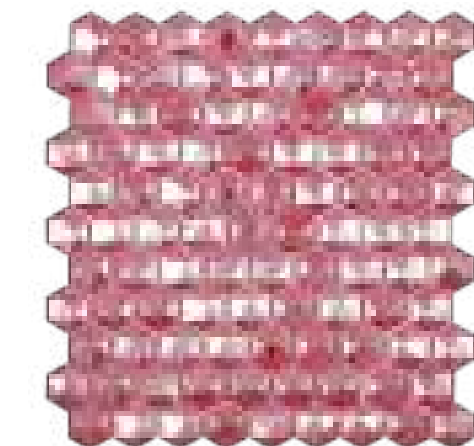

375/D DIAMOND VENETIAN HEX

137

FORMATO - SIZE	PLACA SHEET PLAQUE			CAJA BOX CAISSE			PALET PALLET PALETTE		
	PIEZAS PIECES	MEDIDA DIMENSIONS	KGS KGS	PLACAS SHEET	M ² SQM	KGS KGS	CAJAS BOXES	M ² SQM	KGS KGS
35x35 MM D	99	317x307	1,10	10	0,87	10,96	126	109,62	1.380,96





138

AURA WHITE



ELEMENTS COLLECTION

Las nuevas tendencias en decoración potencian los relieves y efectos en 3d en el revestimiento. Vidrepur lanza la nueva colección elements, donde se aúnan nuevos colores y efectos, que combinados con las prestaciones del mosaico vítreo en relieve permiten combinaciones muy atractivas para revestir cualquier espacio.

New design trends embrace 3d effects and volumes on surfaces. Vidrepur creates a new collection, elements, blending new colours and effects, which combined with the advantages of glass mosaics, provides startling blends for a variety of applications.

Les nouvelles tendances en décoration allient reliefs et effets 3d dans les revêtements. Vidrepur lance elements, la nouvelle collection qui marie des nouvelles couleurs et effets à la magie de la mosaïque de verre en relief pour créer des combinaisons très attrayantes qui parent n'importe quel espace.

139





AURA SILVER

AURA COLLECTION | 25x25 MM | 1"x1" ■ ◁ ◻ ○



AURA WHITE

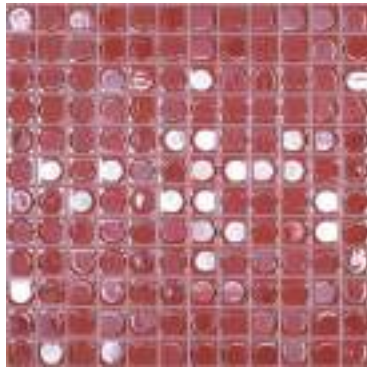

AURA SOFT RED

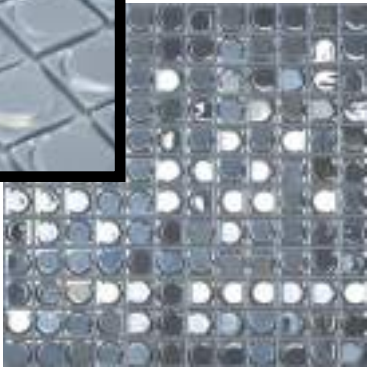
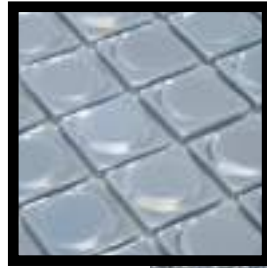

AURA SILVER

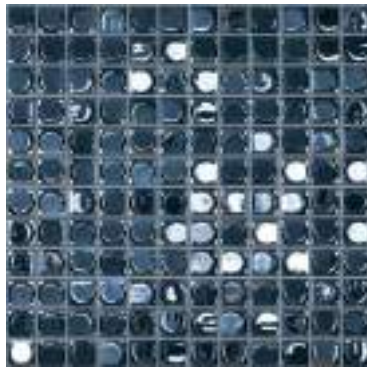

AURA DARK BLUE

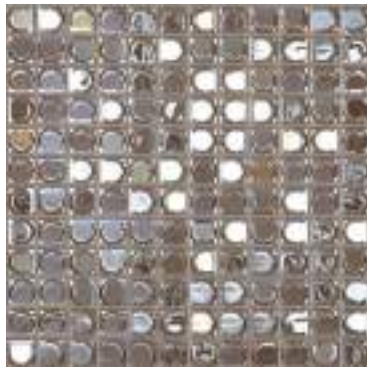

AURA COFFEE

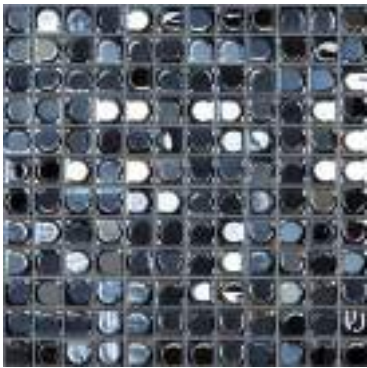

AURA BLACK



AURA CORAL BLEND



AURA CLASSIC BLEND



AURA NUDE BLEND



AURA NIGHT BLEND



EDNA WHITE



EDNA BLACK



EDNA DARK BLUE

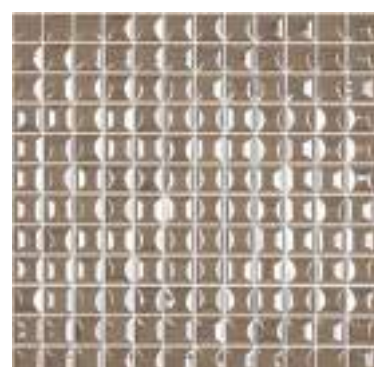

EDNA COFFEE



EDNA ELEGANT BLEND

FORMATO - SIZE	PLACA SHEET PLAQUE			CAJA BOX CAISSE			PALET PALLET PALETTE		
	PIEZAS PIECES	MEDIDA DIMENSIONS	KGS KGS	PLACAS SHEET	M ² SQM	KGS KGS	CAJAS BOXES	M ² SQM	KGS KGS
25x25 MM EDNA	144	315x315	1,05	10	1	10,5	126	126	1.323,00
25x25 MM AURA	144	315x315	0,97	10	1	9,73	126	126	1.225,98

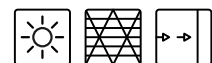

EDNA WHITE, EDNA COFFEE, EDNA ELEGANT BLEND



146

452 PEARL CIELO



PEARL COLLECTION

Es la colección más especial de Vidrepur. Inspirada en las perlas naturales, pearl en formato 1x1 cm es una colección de lujo para espacios de lujo. Amplia gama de colores y usos versátiles para cualquier espacio, incluso la podemos utilizar como cenefa en piscinas o en lugares húmedos de grandes proyectos.

The most special collection offered by Vidrepur. Inspired by natural pearls, the pearl collection comes in a 1x1 cm size to offer a lavish collection for luxury spaces. The collection offers a wide range of colours and offers versatile uses. The tiles can even be used as edging for swimming pools, or in other wet areas in large projects.

C'est la collection la plus spéciale de Vidrepur. Puisant son inspiration dans les perles naturelles, pearl au format 1x1cm est une collection de luxe pour des espaces de luxe. Grâce à un large éventail de couleurs et des utilisations diverses, elle s'adapte à tous les espaces, pouvant notamment être employée comme frise de piscine ou dans les zones humides de vos grands projets.

147



450 PEARL NACAR

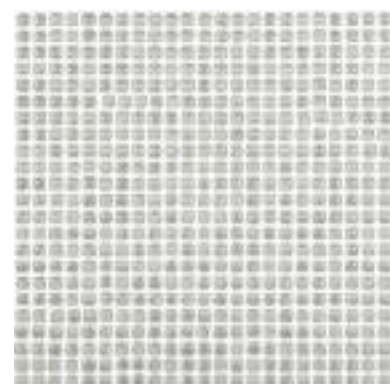

451 PEARL GRIS



459 PEARL CHOCOLATE

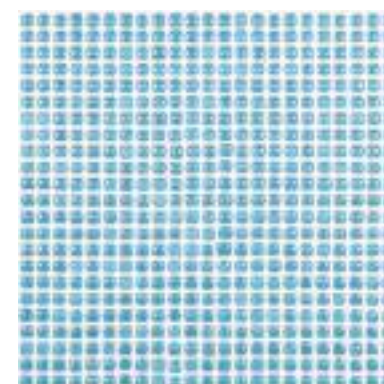

452 PEARL CIELO

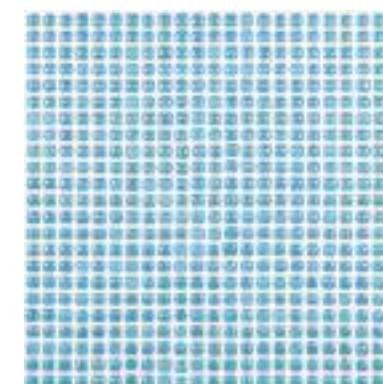

458 PEARL LUMINISCENTE

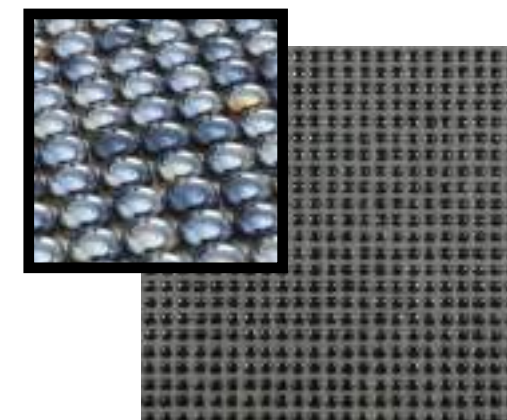

457 PEARL ANTRACITA

148



450 PEARL NACAR, 457 PEARL ANTRACITA



455 PEARL CORAL

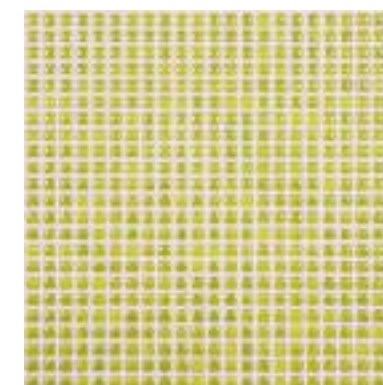

454 PEARL PISTACHO

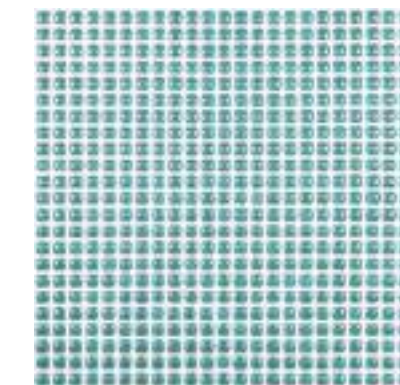

456 PEARL TURQUESA

149

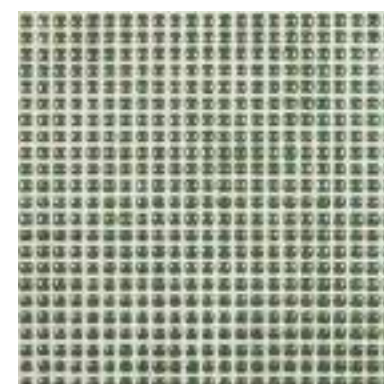

460 PEARL VERDE

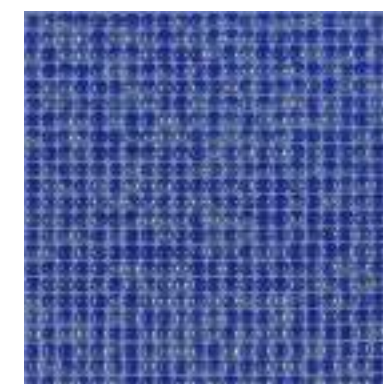

453 PEARL COBALTO



CONSEJOS DE COLOCACIÓN

FORMATO - SIZE	PLACA SHEET PLAQUE			CAJA BOX CAISSE			PALET PALLET PALETTE		
	PIEZAS PIECES	MEDIDA DIMENSIONS	KGS KGS	PLACAS SHEET	M ² SQM	KGS KGS	CAJAS BOXES	M ² SQM	KGS KGS
12x12 MM	529	309x309	0,93	10	1	9,25	126	126	1.165,50

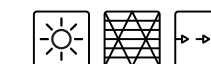



150

652 MOON WHITE, 658 MOON SILVER



MOON COLLECTION

Fruto de nuestra constante investigación, nace moon con su combinación de texturas y una apariencia singular.

La gama cromática elegida permite que la combinación de brillos y mates en la misma tesela ofrezca un acabado novedoso y muy útil para combinar con otros materiales y decorar cualquier estilo.

Moon es un producto para permitir imaginar cualquier combinación.

The fruit of our continuous research, moon is born with its combination of textures and its unique appearance.

The chosen chromatic range offers, through its combination of glosses and matts, in the same tessera, an inovative finishing, very useful in combining other materials and for decorating any style.

Moon is a product that allows any combination to be imagined.

De nos recherches constantes est née moon avec sa combinaison de textures et son apparence singulière.

La gamme chromatique choisie permet à la combinaison de mats et brillants sur une même tesselle d'offrir une finition innovante et très utile pour combiner avec d'autres matériaux et décorer tous les styles.

Moon est un produit qui permet d'imaginer toutes les combinaisons.

151

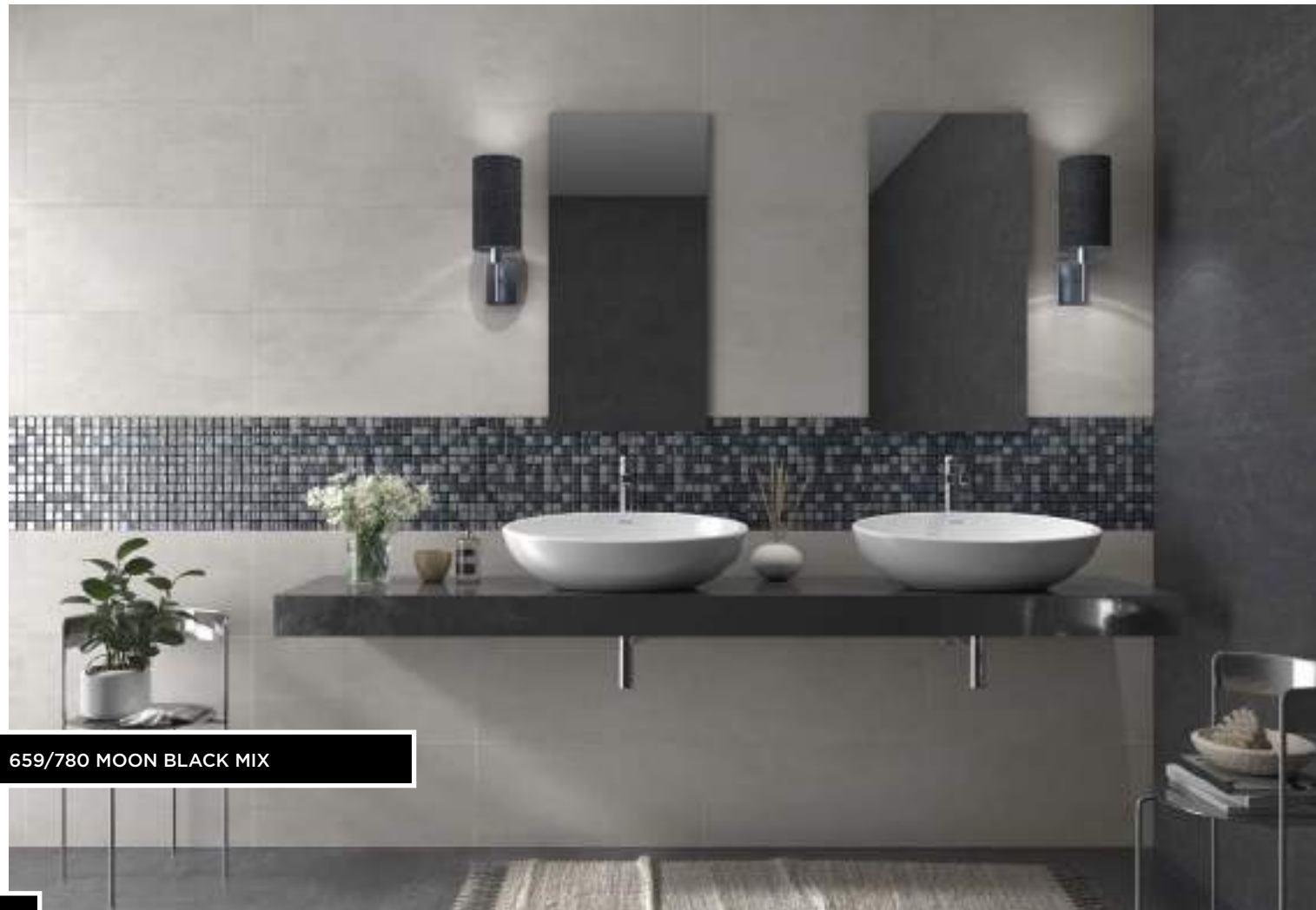

659/780 MOON BLACK MIX



651 MOON METALLIC

MOON COLLECTION

25x25 MM | 1"x1"



650 MOON RED



651 MOON METALLIC



652 MOON WHITE



658 MOON SILVER



659 MOON BLACK



660 MOON BLUE

MOON BLENDS



652/710 MOON WHITE MIX



659/780 MOON BLACK MIX



FORMATO DISPONIBLE EN 25X50 MM / FORMAT AVAILABLE IN 25X50 MM

FORMATO - SIZE	PLACA SHEET PLAQUE			CAJA BOX CAISSE			PALET PALLET PALETTE		
	PIEZAS PIECES	MEDIDA DIMENSIONS	KGS KGS	PLACAS SHEET	M ² SQM	KGS KGS	CAJAS BOXES	M ² SQM	KGS KGS
25x25 MM	144	315x315	0,90	10	1	9	126	126	1.134,00
50x25 MM	72	315x315	1,01	10	1	10,125	126	126	1.275,75

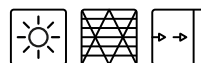



ARTS COLLECTION

Las texturas, acabados y colores de la colección arts ofrecen presencia y elegancia para combinar con todos los estilos. La combinación de colores y texturas hace que podamos utilizar esta colección para la fusión de estilos en nuestro hogar y convertir ambientes en espacios multifuncionales.

La colección está pensada para combinar con otros materiales y convive perfectamente con cerámica, madera, cemento...

The colours of the arts collection are of such elegance that they can be combined with all styles. This collection's combination of colour and texture allows us to blend styles in our home, turning moods into multifunctional spaces.

This collection is designed to be combined with other materials and blends perfectly with ceramics, wood, cement, etc.

Les textures, les finitions et les couleurs de la collection arts offre présence et élégance pour combiner avec tous les styles. La combinaison de couleurs et textures nous permet d'utiliser cette collection pour fusionner les styles de notre maison et transformer des ambiances en espaces multifonctionnels.

La collection est prévue pour être combinée avec d'autres matériaux et se marie facilement avec la céramique, le bois, le ciment...

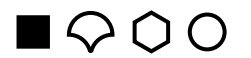

1046 ARTS SILVER BRUSH



950 ARTS ANTARTICA

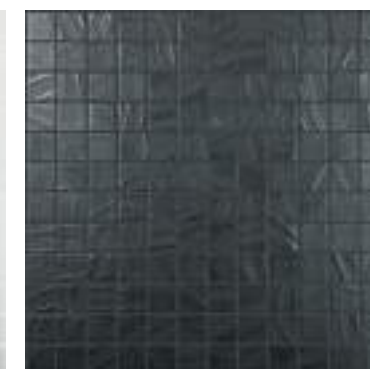

951 ARTS BLACK ANTHRACITE

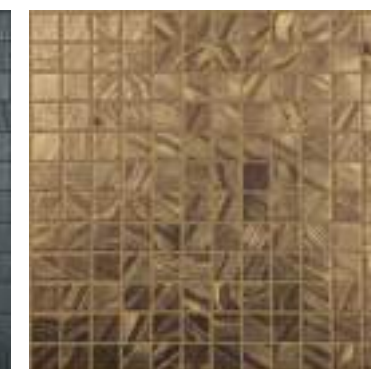

952 ARTS SATIN GOLD



1046 ARTS SILVER BRUSH

FORMATO - SIZE	PLACA SHEET PLAQUE			CAJA BOX CAISSE			PALET PALLET PALETTE		
	PIEZAS PIECES	MEDIDA DIMENSIONS	KGS KGS	PLACAS SHEET	M ² SQM	KGS KGS	CAJAS BOXES	M ² SQM	KGS KGS
25x25 MM	144	315x315	0,91	10	1	9,125	126	126	1.149,75

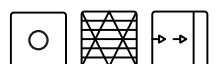

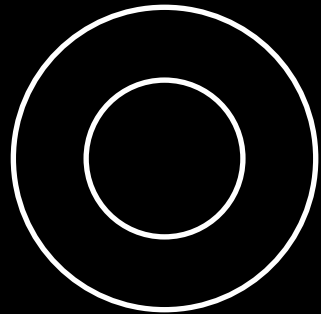
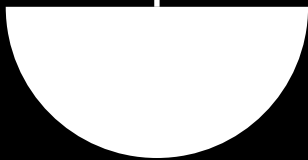
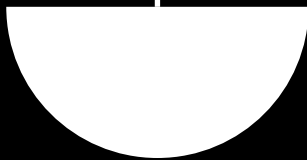
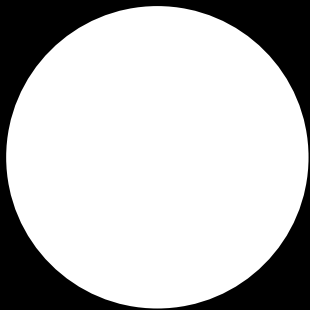

SWIMMING POOLS

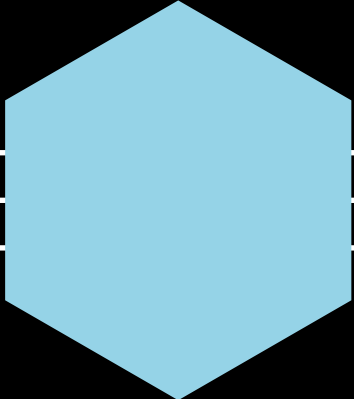
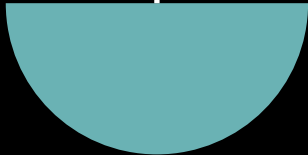
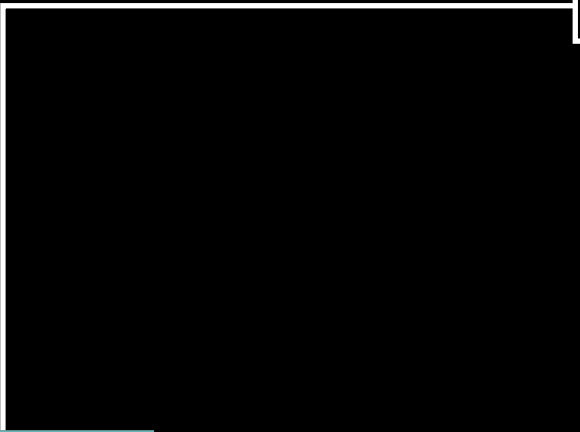

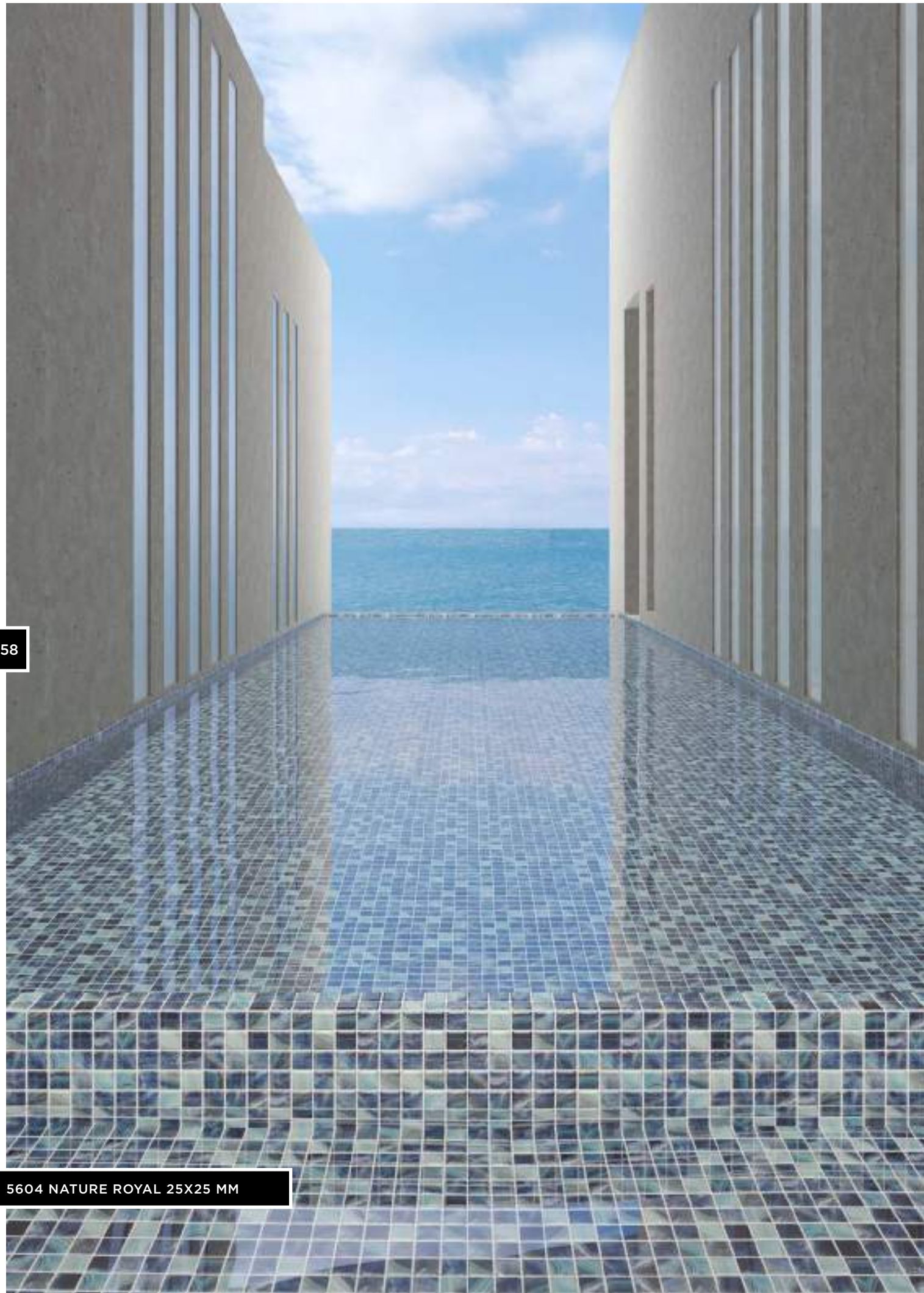

5604 NATURE ROYAL 25X25 MM

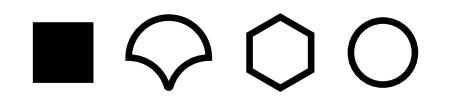

NATURE COLLECTION

Existe el diseño y existe el arte. El buen diseño siempre desprende armonía. Pero no hay mejor diseñador que la propia naturaleza. Fíjate en esa rama o en esa hoja, son perfectas. El Arte trata sobre las emociones, el sufrimiento y la belleza y la naturaleza es ese arte que se estremece!

There's design, and there's art. There's no better designer than nature - if you look at a branch or a leaf, it's perfect. Art is different. It's about emotion. It's about suffering and beauty - but mostly shudder!

D'un côté il y a le design et de l'autre l'art. Un bon design génère toujours de l'harmonie. Mais il n'existe pas de meilleur designer que la nature elle-même. Observez cette branche ou cette feuille, elles sont parfaites. L'Art aborde les émotions, la souffrance et la beauté, et la nature est cet art qui frémit !

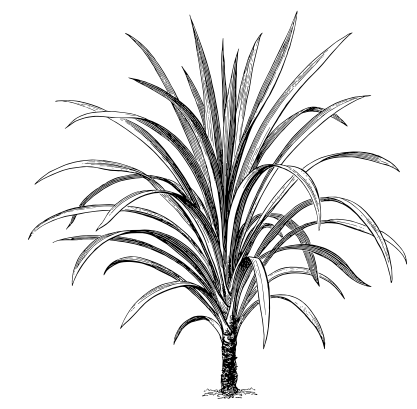

HARMONY WITH NATURE





160

5606 NATURE AIR FORCE 25X25 MM



161

5605 NATURE OLYMPIC 25X25 MM



5604 NATURE ROYAL 38X38 MM

162



5604 NATURE ROYAL 38X38 MM



5600 NATURE PEARL 38X38

163



5601 NATURE SEA SALT 38X38



5600 NATURE PEARL RIVER 25X25 MM



5601 NATURE SEA SALT



5600 NATURE PEARL RIVER



5606 NATURE AIR FORCE



5601 NATURE SEA SALT



5600 NATURE PEARL RIVER



5606 NATURE AIR FORCE

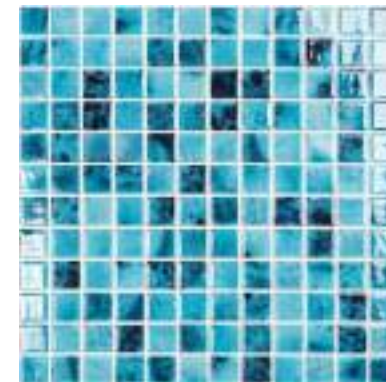

5605 NATURE OLYMPIC



5604 NATURE ROYAL



5607 NATURE SKY



5605 NATURE OLYMPIC



5604 NATURE ROYAL



5607 NATURE SKY

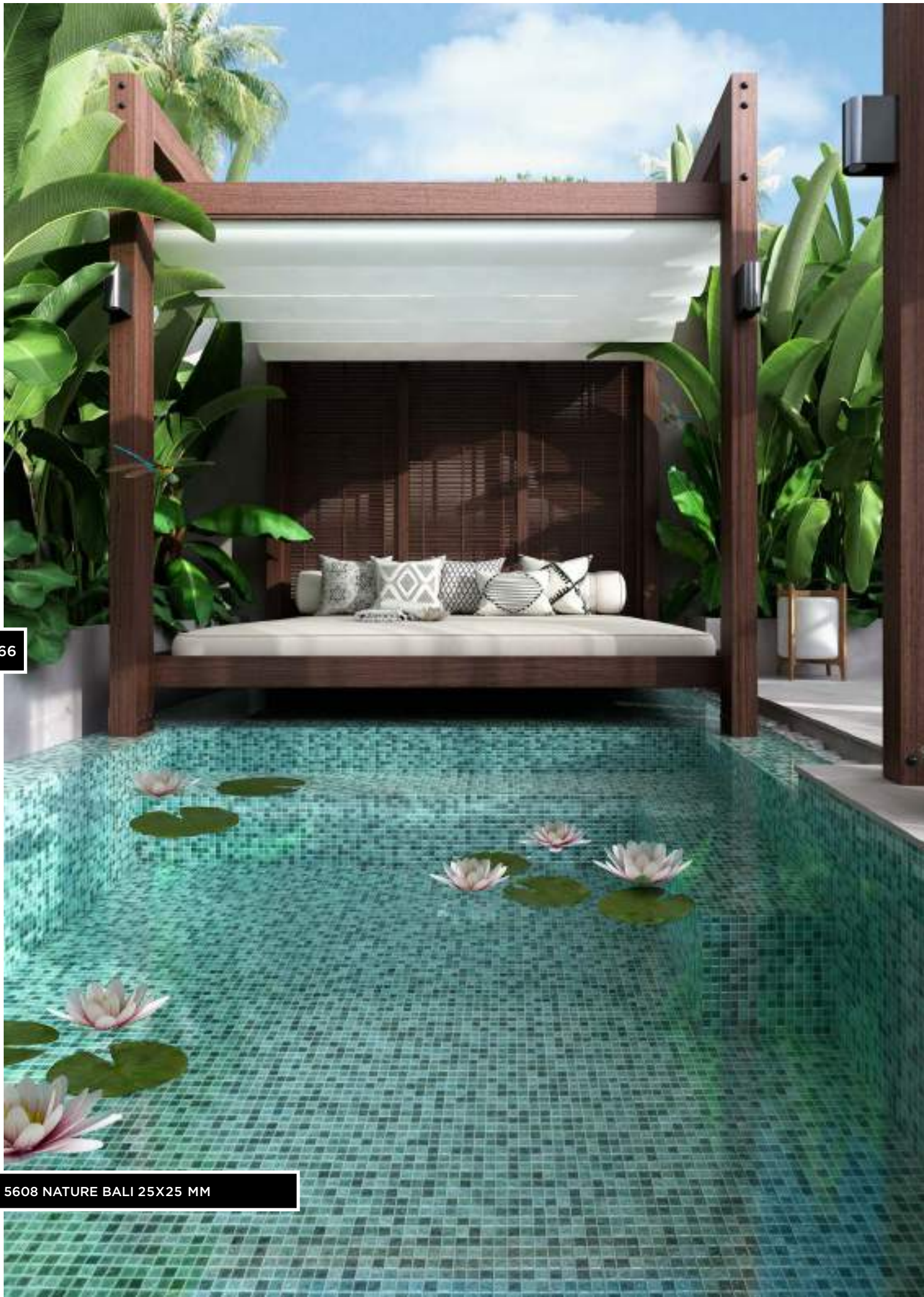

166

5608 NATURE BALI 25X25 MM



5608 NATURE BALI



5603 NATURE JUNGLE



5608 NATURE BALI



5603 NATURE JUNGLE

167

* REFERENCIAS DISPONIBLES EN ACABADO ANTIDESLIZANTE
 * AVAILABLE REFERENCES IN ANTISLIP FINISHED
 * RÉFÉRENCES DISPONIBLES EN FINITIONS ANTIDÉRAPANTES



FORMATO - SIZE	PLACA SHEET PLAQUE			CAJA BOX CAISSE			PALET PALLET PALETTE		
	PIEZAS PIECES	MEDIDA DIMENSIONS	KGS KGS	PLACAS SHEET	M ² SQM	KGS KGS	CAJAS BOXES	M ² SQM	KGS KGS
25x25 MM	144	315x315	0,90	20	2	18	63	126	1.134,00
38x38 MM	64	315x315	1,040	20	2	21,166	63	126	1348.46

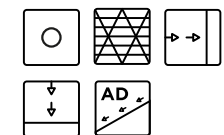



168

5701 NATURE SEA SALT MT 38X38 MM



5701 NATURE SEA SALT MT



5700 NATURE PEARL RIVER MT

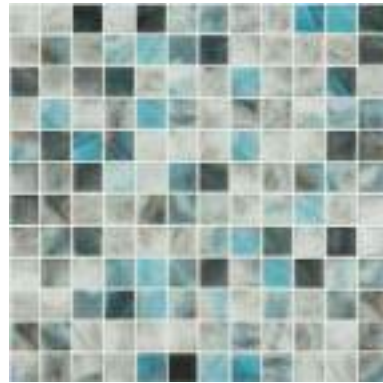

5706 NATURE AIR FORCE MT



5701 NATURE SEA SALT MT



5700 NATURE PEARL RIVER MT



5706 NATURE AIR FORCE MT

169



5705 NATURE OLYMPIC MT



5704 NATURE ROYAL MT



5707 NATURE SKY MT

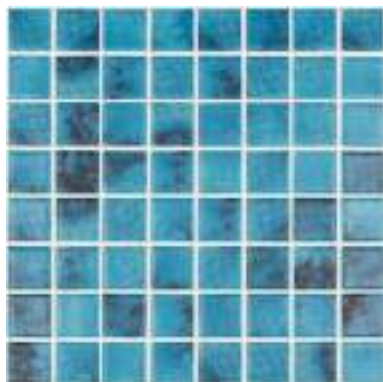

5705 NATURE OLYMPIC MT



5704 NATURE ROYAL MT



5707 NATURE SKY MT



170

5701 NATURE SEA SALT 38X38 MM



171



5708 NATURE BALI MT

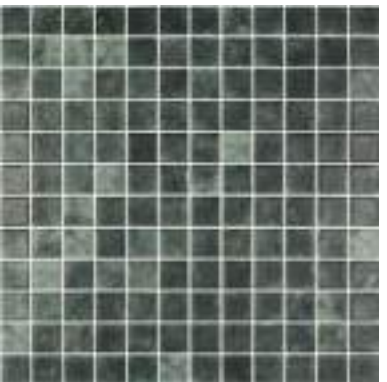

5703 NATURE JUNGLE MT



5708 NATURE BALI MT

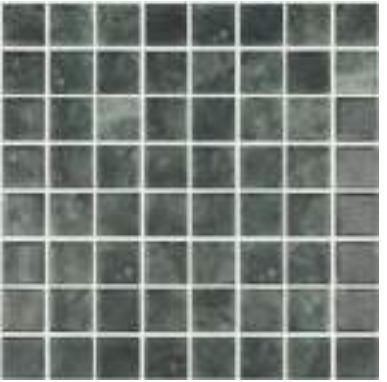

5703 NATURE JUNGLE MT

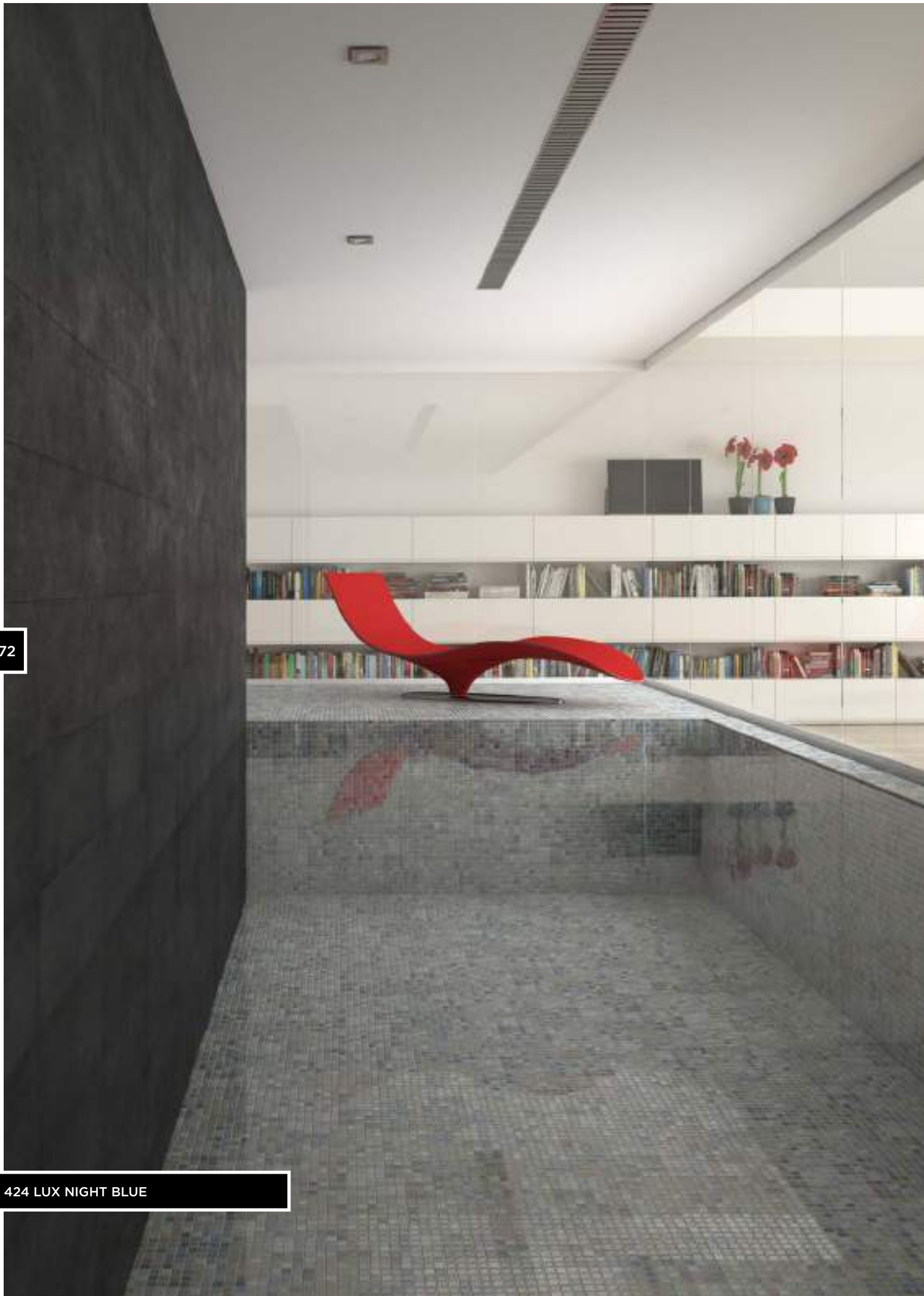

LUX COLLECTION

Con sus destellos de luz y combinaciones de tonalidades esta colección es un verdadero lujo en mosaico vitreo. La ráfaga de luz y brillo, capta nuestra atención al sentirnos atraídos por su luminosidad

Colores brillantes que hacen que la colección lux llene espacios de luz y logre efectos visuales, ofreciendo la posibilidad de ambientar espacios alegres en todos los estilos.

With light reflecting off its glinting surface and its combinations of fade this collection is a real luxury in glass mosaic. The flash of light and shine capture our attention, and attract us with their brightness.

The bright colours of the lux collection fill spaces with light, creating visual effects.

Avec ses éclats de lumière et ses combinaisons de tonalités cette collection est un vrai luxe en mosaïque de verre. La rafale de lumière et d'éclat capte notre attention car sa luminosité nous attire

Des couleurs brillantes qui font que la collection lux remplit les espaces de lumière et crée des effets visuels, tout en offrant la possibilité de créer des espaces allègres et dans tous les styles.

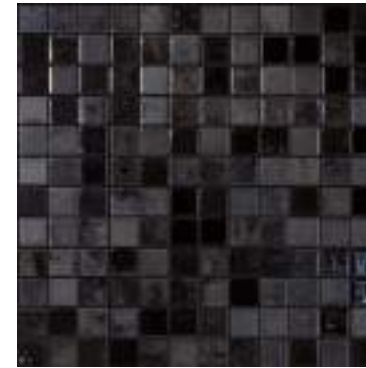

407 LUX ANTHRACITE *

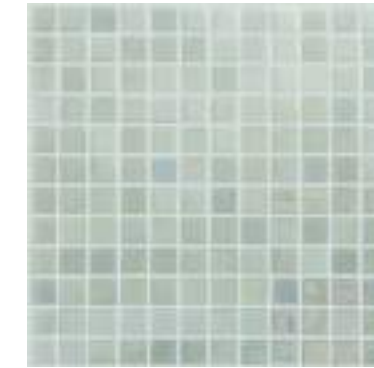

409 LUX WHITE *

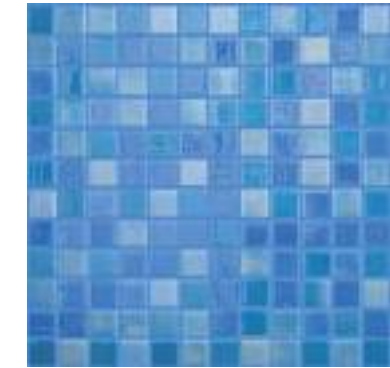

403 LUX LIGHT BLUE *

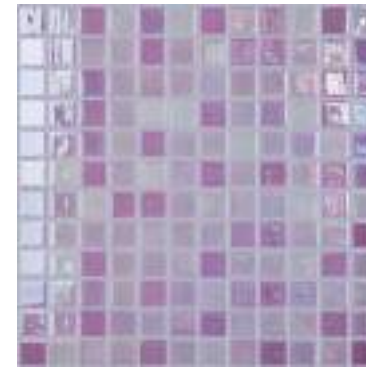

404 LUX MAGENTA

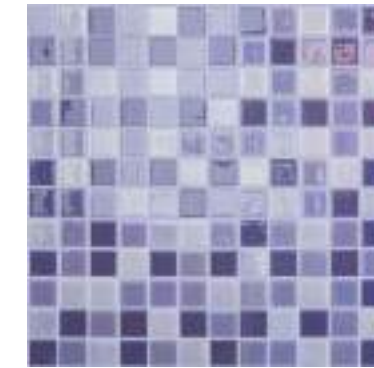

405 LUX LILA



406 LUX CHOCOLATE

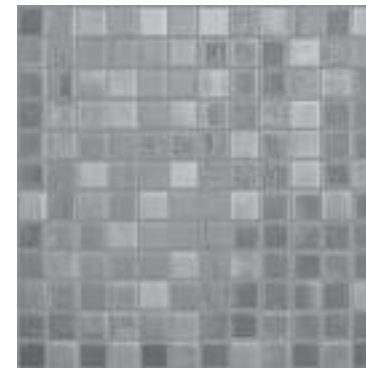

418 LUX GREY



424 LUX NIGHT BLUE

* REFERENCIAS DISPONIBLES EN ACABADO ANTIDESLIZANTE
 * AVAILABLE REFERENCES IN ANTISLIP FINISHED
 * RÉFÉRENCES DISPONIBLES EN FINITIONS ANTIDÉRAPANTES



FORMATO - SIZE	PLACA SHEET PLAQUE			CAJA BOX CAISSE			PALET PALLET PALETTE		
	PIEZAS PIECES	MEDIDA DIMENSIONS	KGS KGS	PLACAS SHEET	M ² SQM	KGS KGS	CAJAS BOXES	M ² SQM	KGS KGS
25x25 MM	144	315x315	0,90	20	2	18	63	126	1.134,00
35x35 MM	99	317x307	0,99	10	0,87	9,93	126	109,62	1.251,18

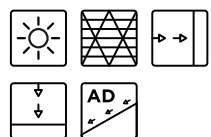

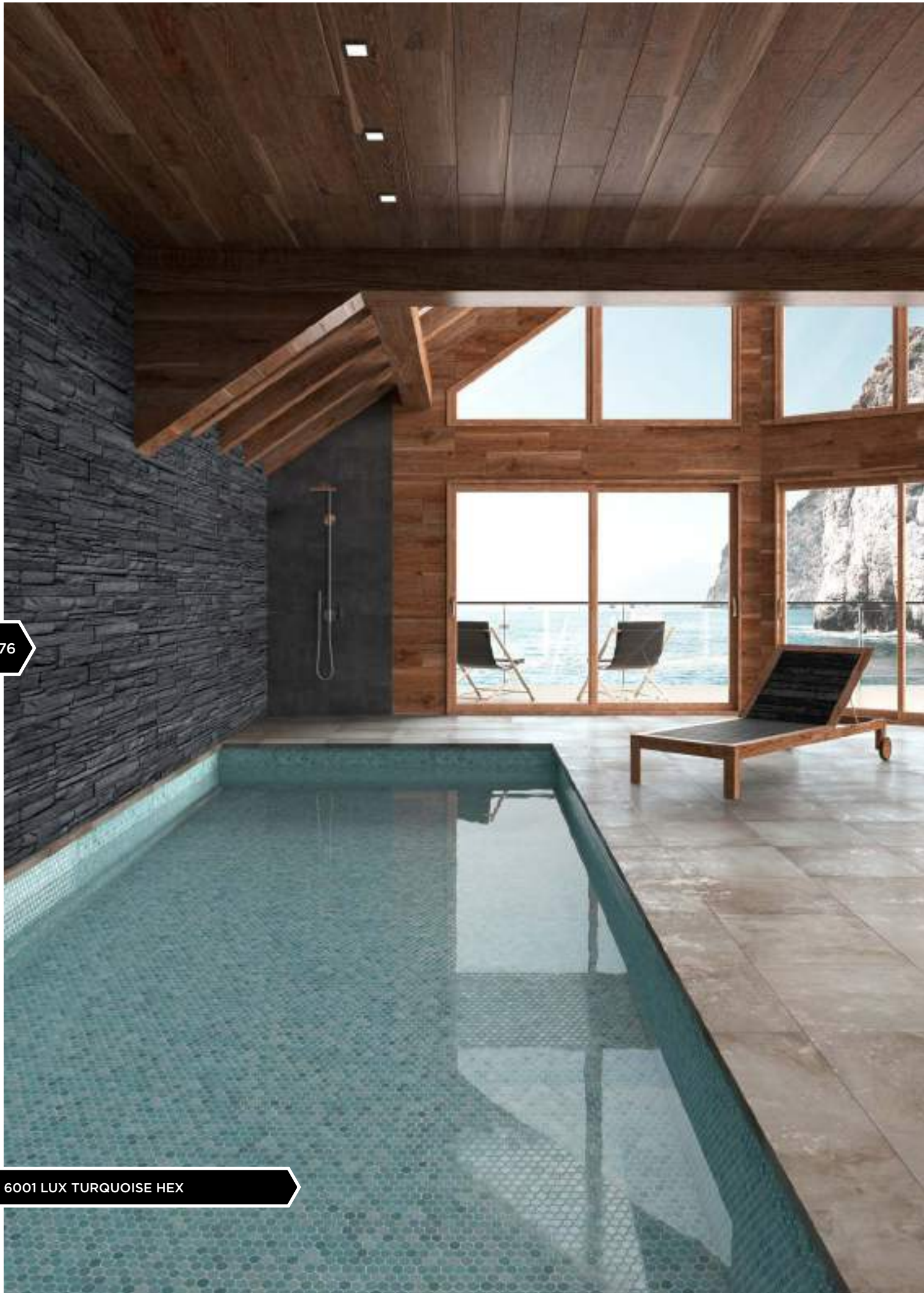

176

6001 LUX TURQUOISE HEX

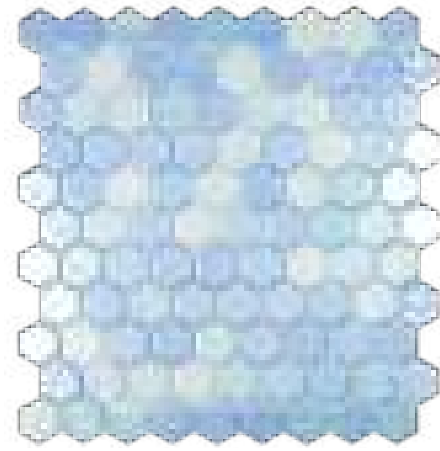

403 LUX LIGHT BLUE HEX

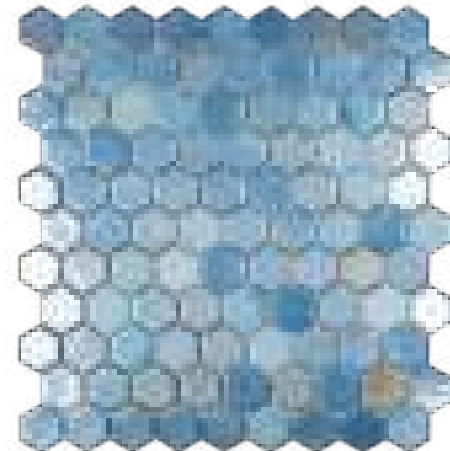

6004 LUX DARK BLUE HEX

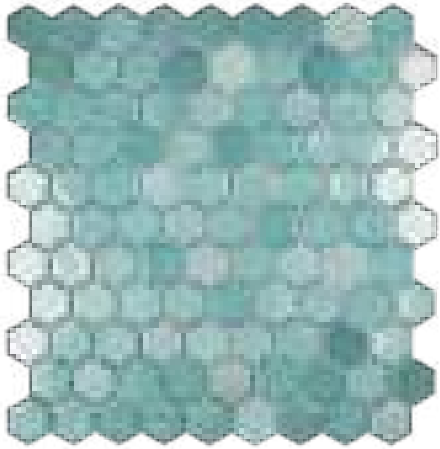

6001 LUX TURQUOISE HEX

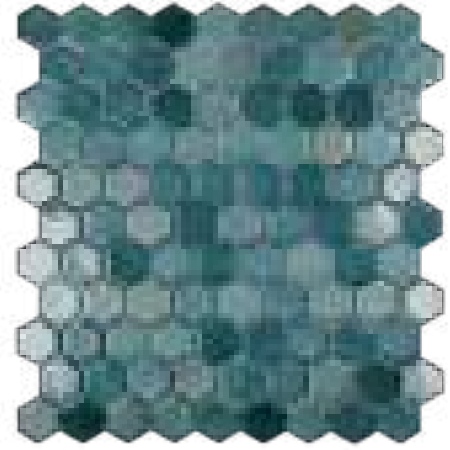

6003 LUX GREEN HEX

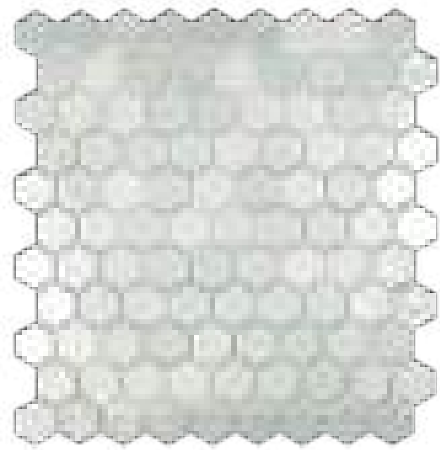

409 LUX WHITE HEX

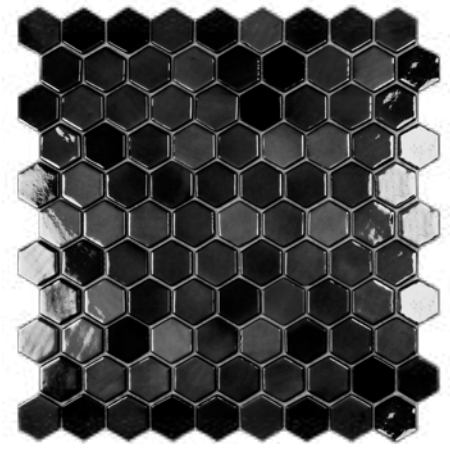

407 LUX ANTHRACITE HEX

177



178

554 SHELL MYSTIC



SHELL COLLECTION

Ante la demanda por parte de importantes clientes, de un producto cada vez más diferencial, destinado principalmente a piscinas, baños o zonas húmedas, vidrepur ha desarrollado la atractiva colección shell, con destellos nacarados en varios colores y muy versátil para todo tipo de piscinas. Shell es la colección que hace que una piscina ofrezca una apariencia más atractiva y luminosa.

With the need to offer to our clients an ever more differentiated product for swimming pools, bathroom and other wet areas, vidrepur has developed a collection with flashes, so we can offer better added value. This collection can give a pool a more attractive and light appearance.

Face à la demande de clients importants d'un produit différentiel, destiné principalement aux piscines, salles de bains ou zone humides, vidrepur a développé la collection shell. Séduisante, dotée de reflets nacrés, déclinée en plusieurs couleurs et très polyvalente pour tout type de piscine. Shell est la collection qui confère aux piscines un aspect plus attrayant et lumineux.

179

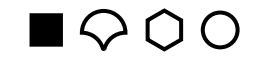

551 SHELL AIR *



552 SHELL AZURE *



555 SHELL SAPPHIRE *



551 SHELL AIR

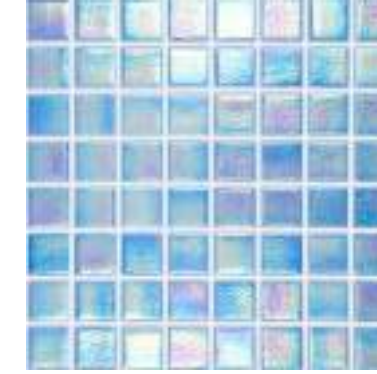

552 SHELL AZURE

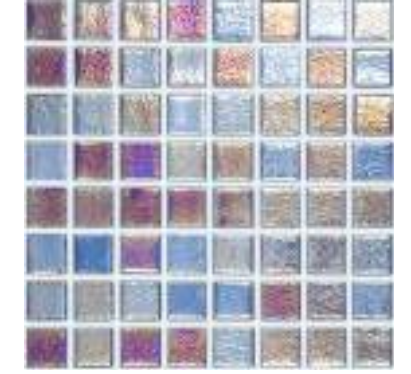

555 SHELL SAPPHIRE

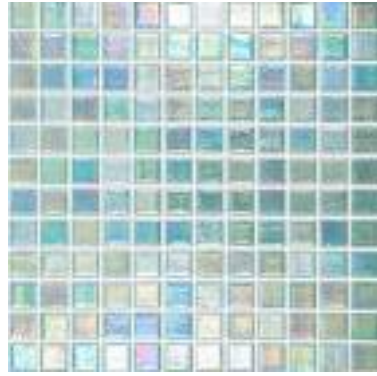

553 SHELL CRYSTAL *

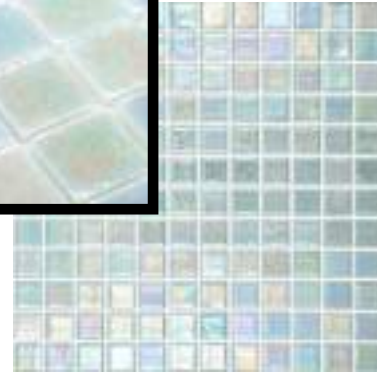
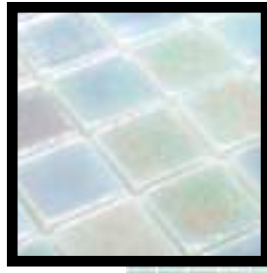

554 SHELL MYSTIC *

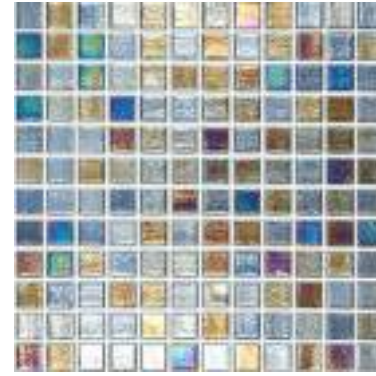

556 SHELL DEEP *



553 SHELL CRYSTAL



554 SHELL MYSTIC

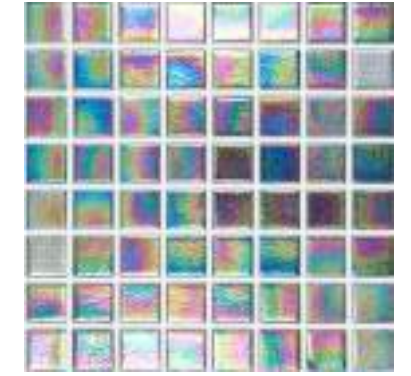

556 SHELL DEEP



557 SHELL STEEL *



558 SHELL LUNAR *



563 SHELL WHITE *



557 SHELL STEEL

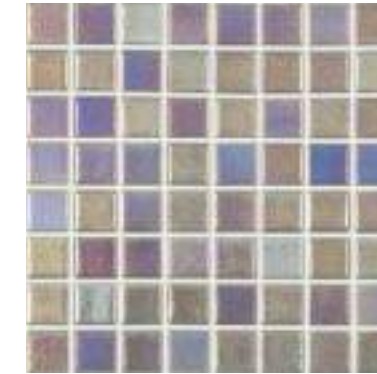

558 SHELL LUNAR

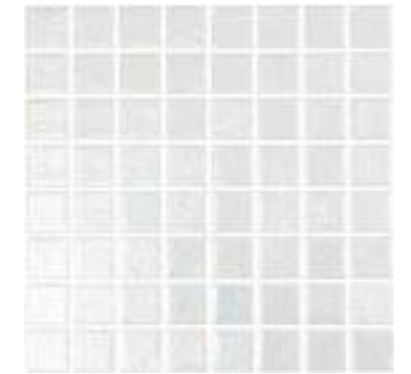

563 SHELL WHITE *





182

553 SHELL CRYSTAL HEX



551 SHELL AIR HEX



553 SHELL CRYSTAL HEX

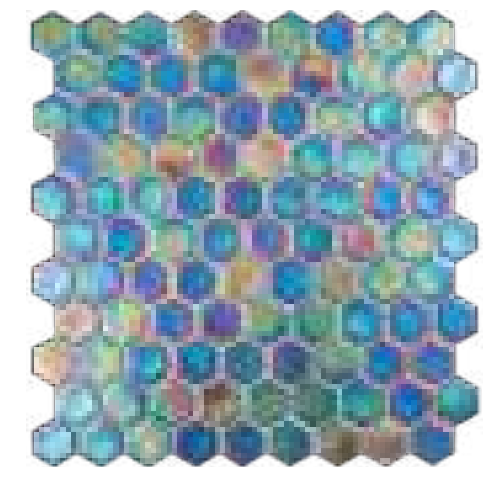

556 SHELL DEEP HEX

183

FORMATO - SIZE	PLACA SHEET PLAQUE			CAJA BOX CAISSE			PALET PALLET PALETTE		
	PIEZAS PIECES	MEDIDA DIMENSIONS	KGS KGS	PLACAS SHEET	M ² SQM	KGS KGS	CAJAS BOXES	M ² SQM	KGS KGS
25x25 MM	144	315x315	0,90	20	2	18	63	126	1.134,00
35x35 MM	99	317x307	0,99	10	0,87	9,93	126	109,62	1.251,18
38x38 MM	64	315x315	1,040	20	2	21,166	63	126	1348,46

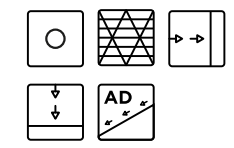

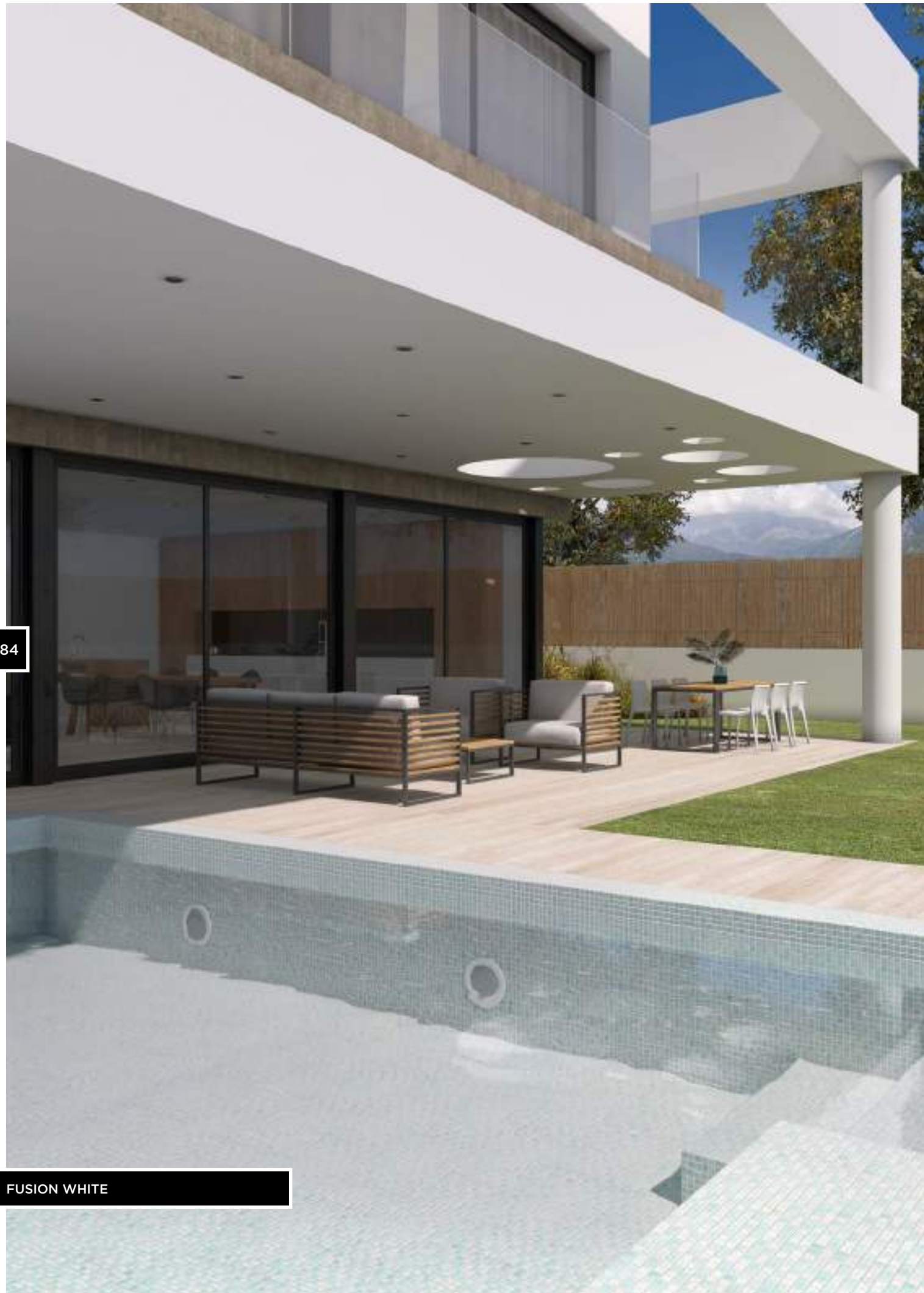

FUSION COLLECTION

Las aguas se vuelven tornasoladas cuando la colección fusion está en las paredes y suelos de nuestras piscinas. Una propuesta sugerente para piscinas, spas, baños, etc.. Que actualiza nuestra gama de productos de gama alta para proyectos.

The waters become iridescent when the fusion collection is on the walls and floors of our pools. An attractive offer for swimming pools, spas, baths and other similar facilities that updates our high-end quality range of products for projects.

Lorsque la collection fusion revêt les parois et les sols de nos piscines, les eaux deviennent chatoyantes. Une proposition aguichante pour les piscines, les spas, les salles de bains, etc. Qui met à jour notre éventail de produits de haut gamme pour des projets.



FUSION LIGH BLUE



FUSION DARK BLUE

FUSION COLLECTION | 25x25 MM | 1"x1" ■ ◁ ○ ○

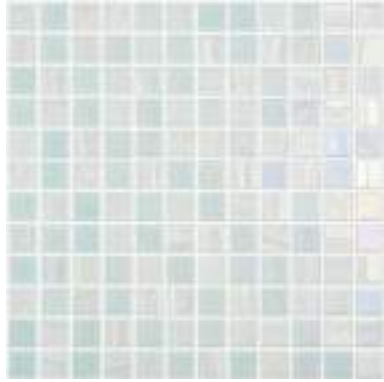

FUSION WHITE

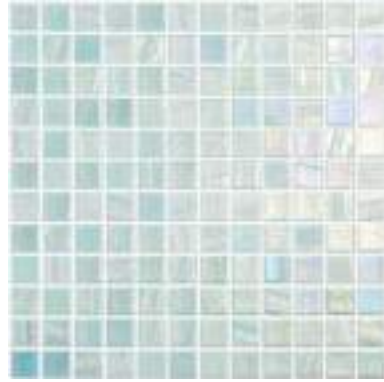

FUSION LIGHT GREEN

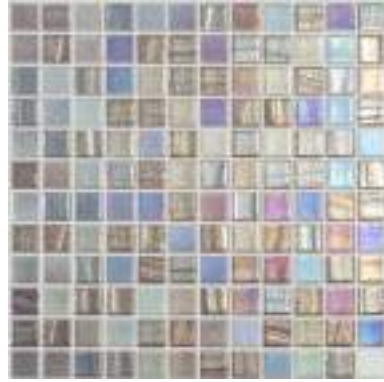

FUSION GREY



FUSION LIGHT BLUE

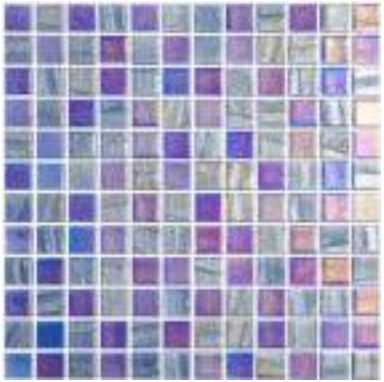

FUSION DARK BLUE

FORMATO - SIZE	PLACA SHEET PLAQUE			CAJA BOX CAISSE			PALET PALLET PALETTE		
	PIEZAS PIECES	MEDIDA DIMENSIONS	KGS KGS	PLACAS SHEET	M ² SQM	KGS KGS	CAJAS BOXES	M ² SQM	KGS KGS
25x25 MM	144	315x315	0,90	20	2	18	63	126	1.134,00

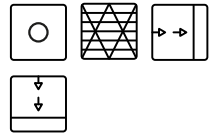

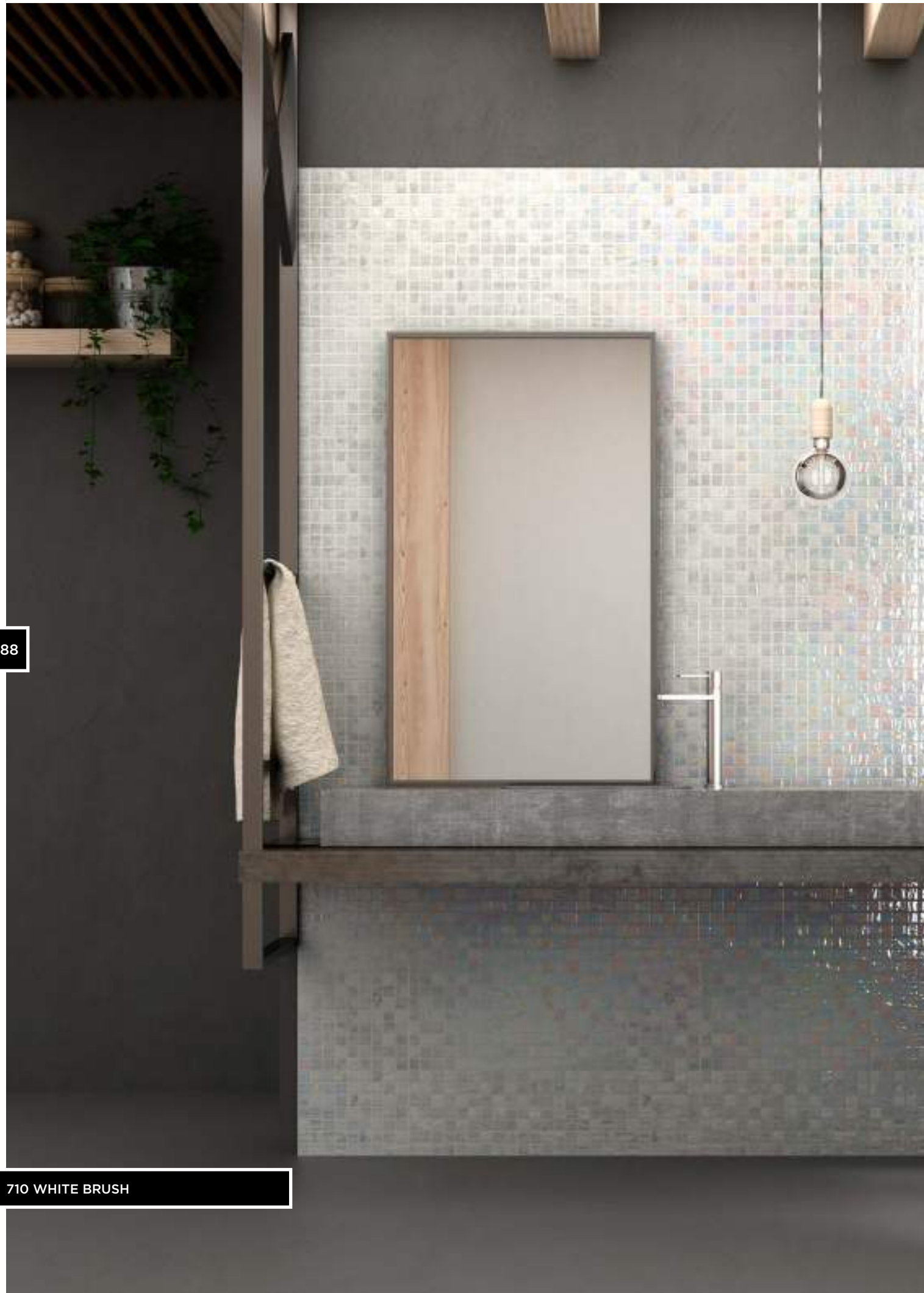

188

710 WHITE BRUSH



TITANIUM COLLECTION

La luz refleja sus destellos y la calidez vítrea se transforma en sensaciones para decorar. El brillo de cada color hace que esta colección ofrezca múltiples posibilidades para iluminar cada rincón.

Con sus colores podemos crear ambientes con estilos elegantes y frescos y espacios iluminados y confortables a la vista. Crea los estilos más versátiles y vanguardistas del momento con esta colección tan diversa.

The brilliance of each colour allows this collection to offer a wide variety of options to brighten up the space.

The colours of the titanium collection allow us to create elegant and fresh moods, comfortable to the eye. Create the latest, most versatile and innovative styles with this diverse collection.

La lumière reflète ses éclats et la chaleur vitreuse se transforme en sensations pour décorer. L'éclat de ces couleurs permet à cette collection d'offrir de multiples possibilités qui illuminent chaque recoin.

Avec ses couleurs nous pouvons créer des ambiances avec des styles élégants et frais, des espaces illuminés et agréables à voir. Avec cette collection très variée elle crée les styles les plus versatiles et avant-gardistes du moment.

189



722 OCHRE BRUSH



770 RED BRUSH

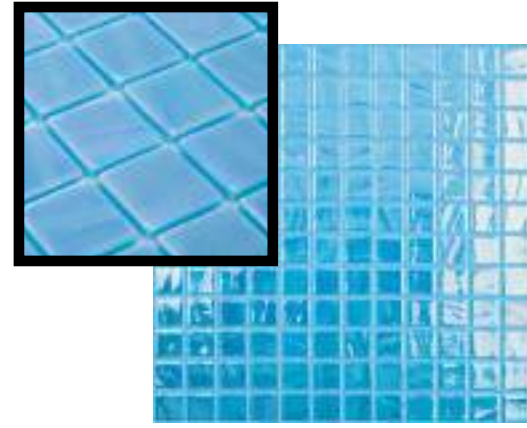

733 SKY BLUE / TURQUOISE BRUSH



325 SAHARA



710 WHITE BRUSH



720 LEMON YELLOW BRUSH



734 BLUE BRUSH



750 BLUE SKY BRUSH



762 GREEN BRUSH



780 BLACK BRUSH



780 BLACK BRUSH

FORMATO DISPONIBLE EN 38X38 MM / FORMAT AVAILABLE IN 38X38 MM

FORMATO - SIZE	PLACA SHEET PLAQUE			CAJA BOX CAISSE			PALET PALLET PALETTE		
	PIEZAS PIECES	MEDIDA DIMENSIONS	KGS KGS	PLACAS SHEET	M ² SQM	KGS KGS	CAJAS BOXES	M ² SQM	KGS KGS
25x25 MM	144	315x315	0,90	10	1	9	126	126	1.134,00
38x38 MM	64	315x315	1,040	20	2	21,166	63	126	1348.46

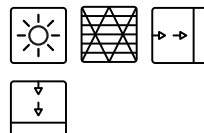

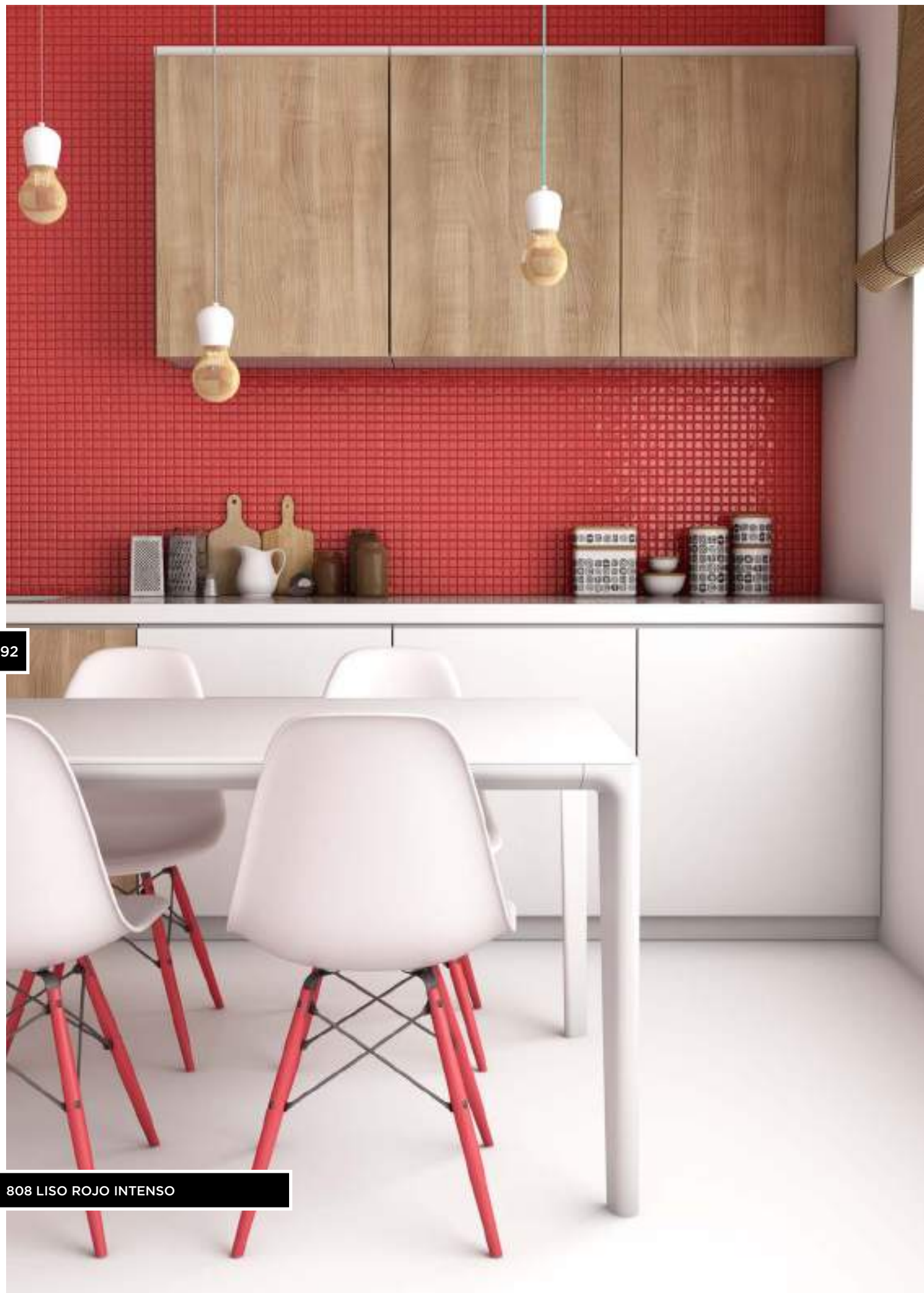

192

808 LISO ROJO INTENSO



COLORS COLLECTION

La ilusión de crear nuevos ambientes, la alegría que desprende un espacio donde el color sea el protagonista. Vitalidad y mosaico vítreo.

Sensaciones ópticas, percepción visual, energía positiva, formas horizontales, formas verticales y soluciones estéticas para cada necesidad con toda la diversidad de tonos que abarca la colección. Contrastes de colores fríos y calidos, fusión de colores vibrantes y fuertes tanto para spas, piscinas, hoteles como para decorar las estancias de tu hogar.

The thrill of creating new environments; the joy of a space where colour is the star. Vitality and vitreous mosaic.

Optical sensations, visual perception, positive energy, horizontal and vertical shapes and aesthetic solutions for every need, all in the wide variety of tones offered in this collection. Contrasts of cold and warm colours, blends of vibrant and strong colours for spas, swimming pools, hotels as well as for decorating your home.

Le plaisir de créer de nouvelles ambiances, la joie que dégage un espace où la couleur est la vedette. Vitalité et mosaïque de verre.

Sensations optiques, perception visuelle, énergie positive, formes horizontales, verticales et solutions esthétiques pour chaque besoin avec toute la diversité de tonalités que la collection englobe. Contrastes de couleurs froides et chaudes, fusion de couleurs vibrantes et fortes pour spas, piscines, hôtels, et pour la décoration des pièces de votre maison.

193



106 LISO AZUL CELESTE

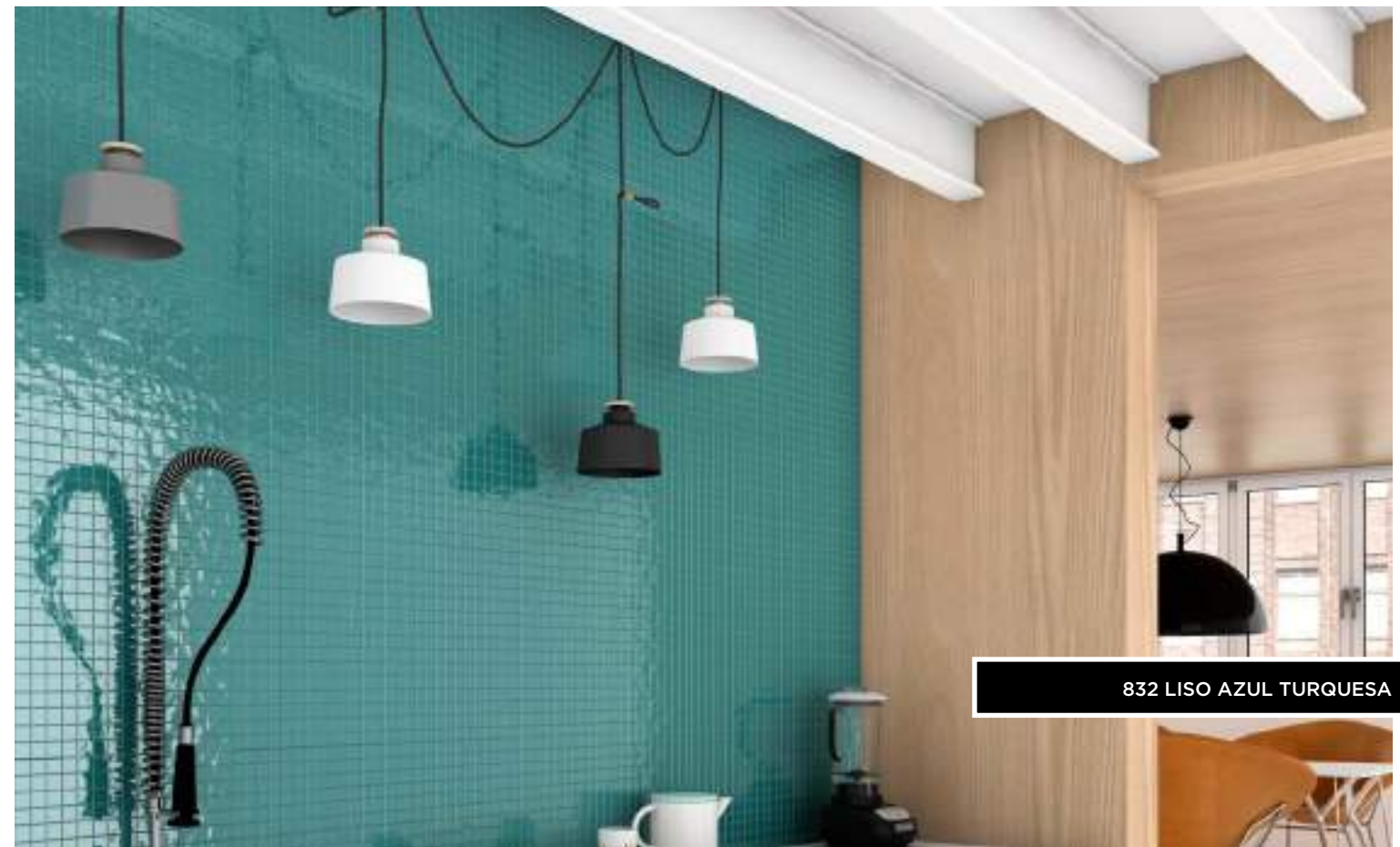

832 LISO AZUL TURQUESA



194

508 NIEBLA AZUL MARINO, 107 FIREGLASS



195

504 NIEBLA NARANJA

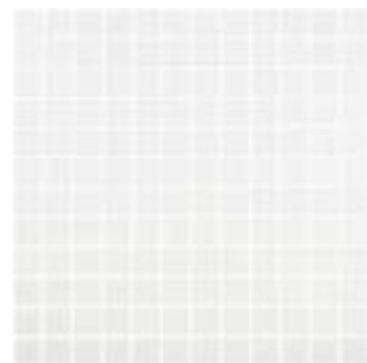

100 LISO BLANCO

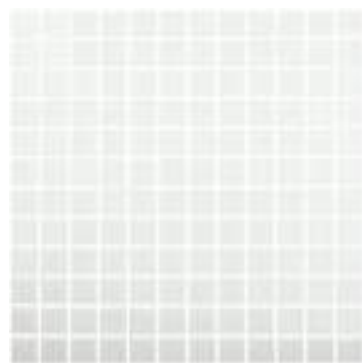

103 LISO MARFIL

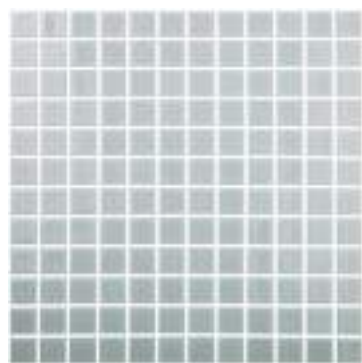

109 LISO GRIS CLARO

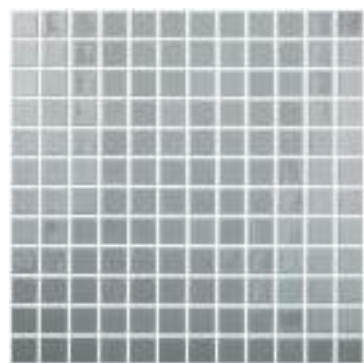

108 LISO GRIS

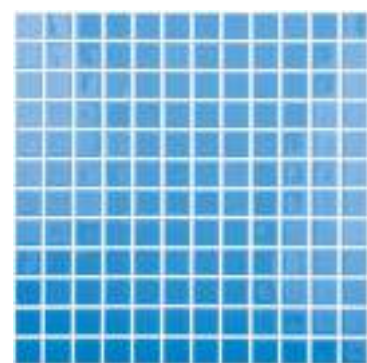

106 LISO CELESTE

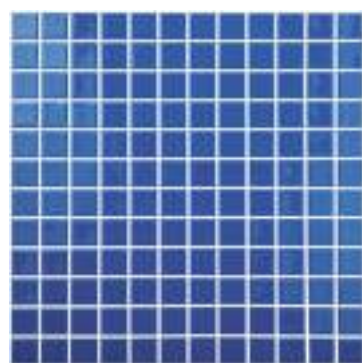

800 LISO AZUL MARINO CLARO



803 LISO AZUL MARINO

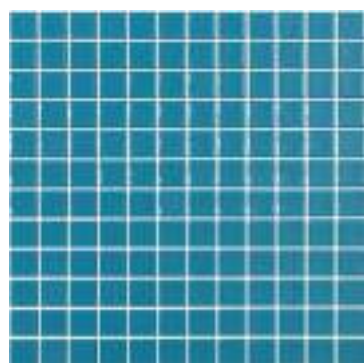

916 LISO AZUL PETROLEO

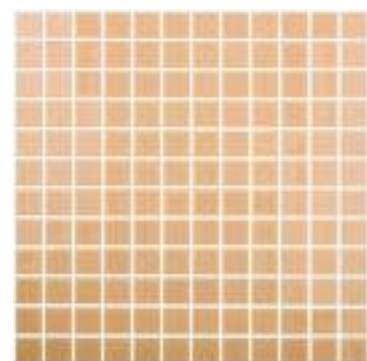

101 LISO BEIGE



831 LISO HUESO



835 LISO MARRON



836 LISO MARRON OSCURO

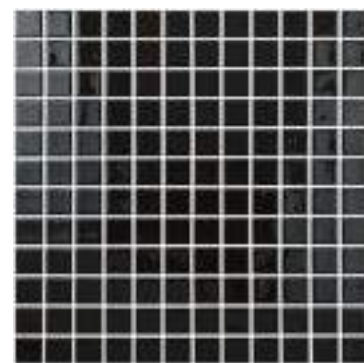

900 LISO NEGRO

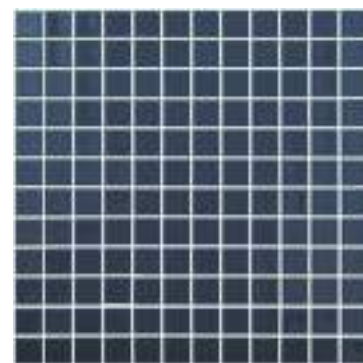

828 LISO ANTRACITA

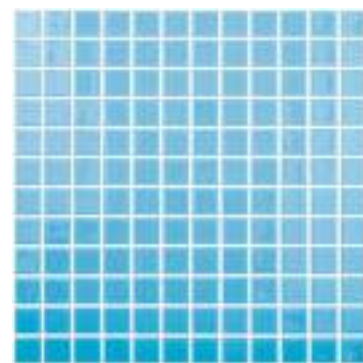

102 LISO TURQUESA

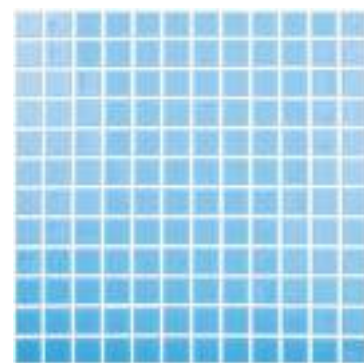

107 LISO CELESTE CLARO



832 LISO AZUL TURQUESA

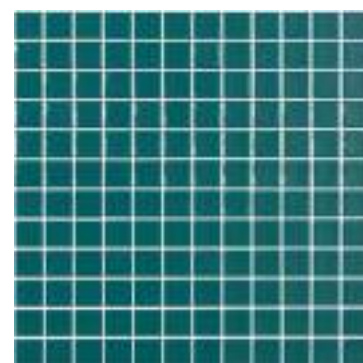

897 LISO VERDE ESMERALDA

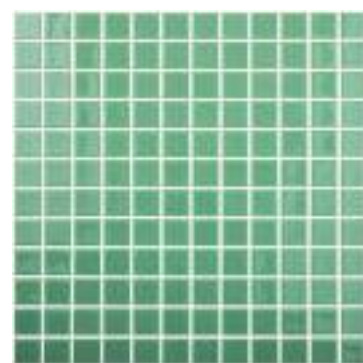

600 LISO VERDE CLARO

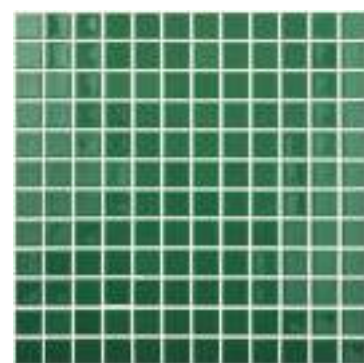

602 LISO VERDE OSCURO

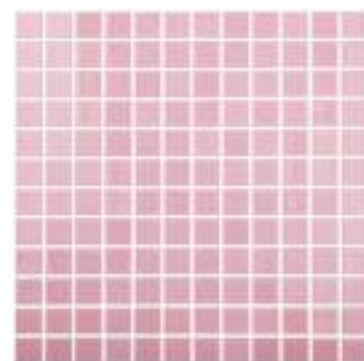

105 LISO ROSA

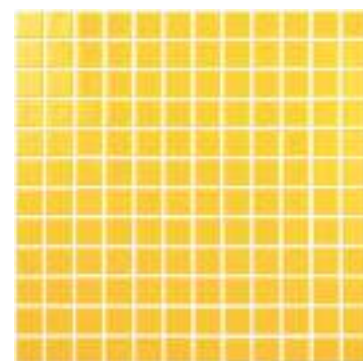

801 LISO AMARILLO

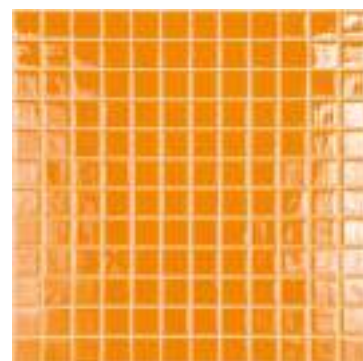

820 LISO NARANJA CITRICO

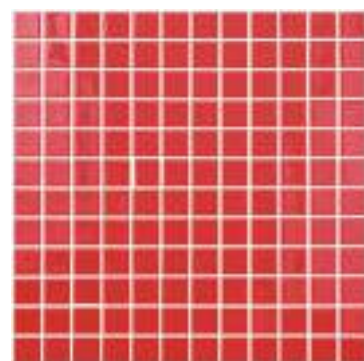

808 LISO ROJO

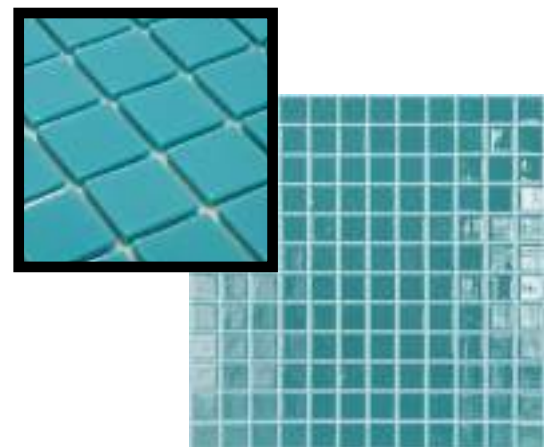

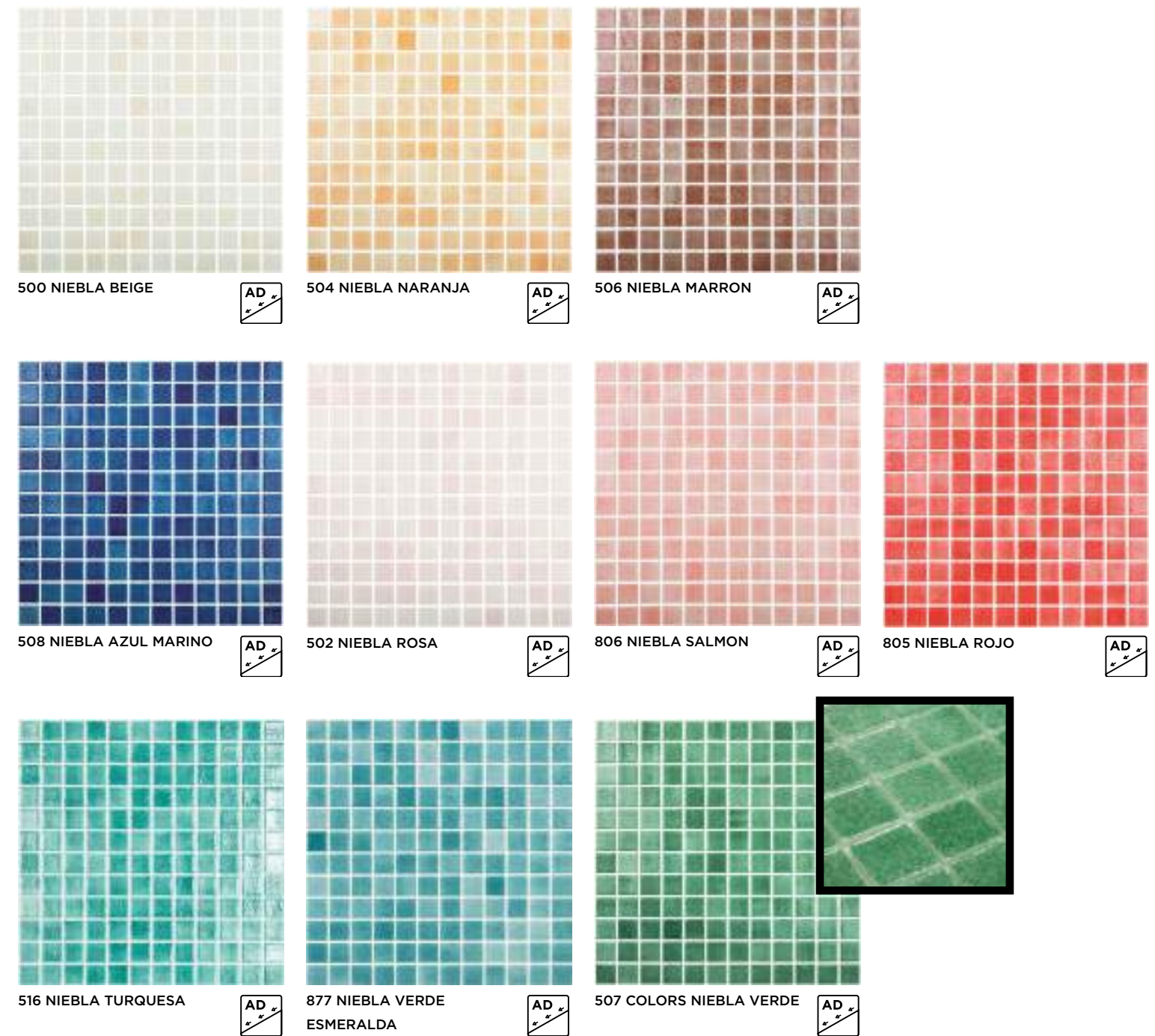
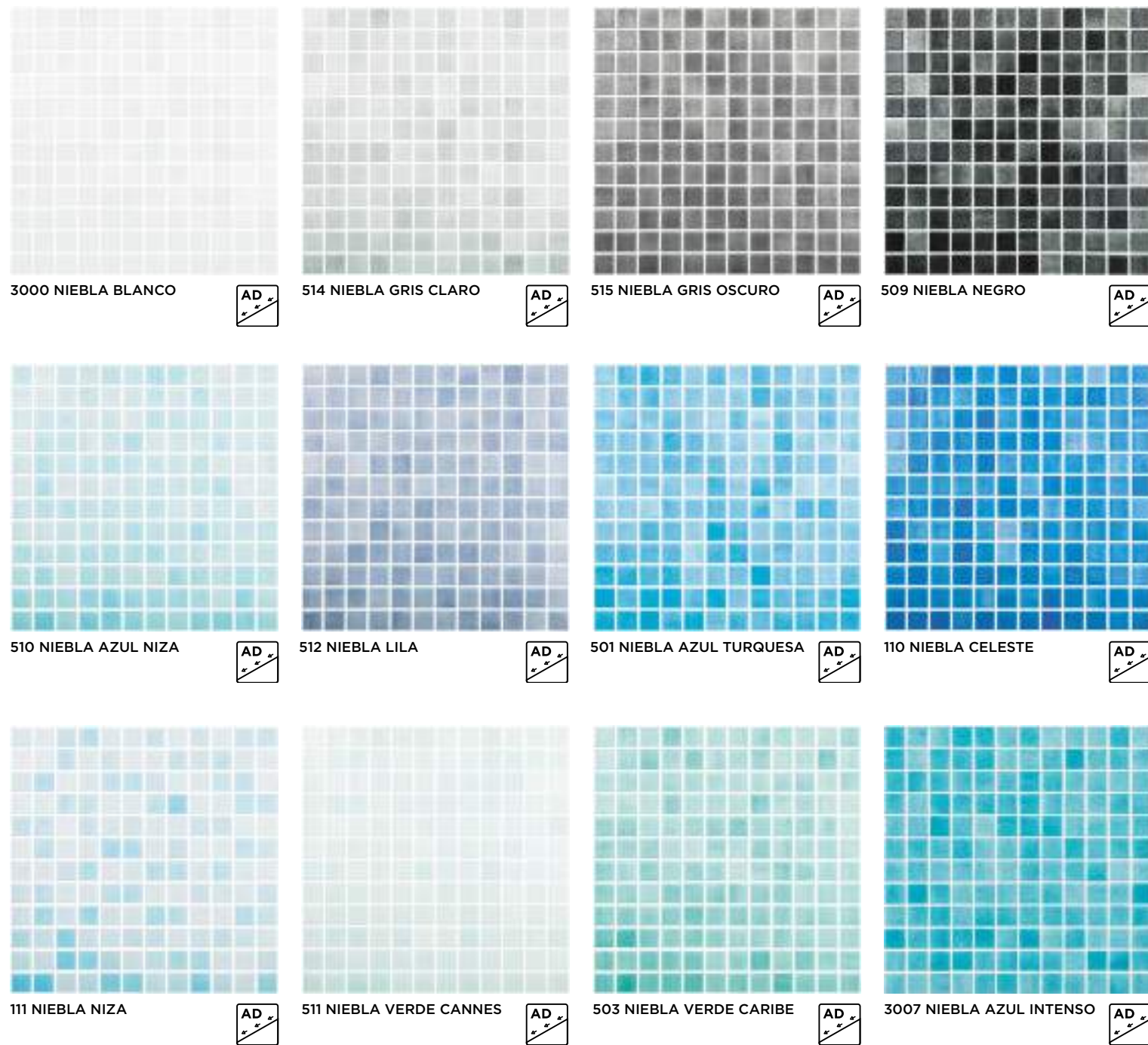

FORMATO DISPONIBLE EN 38X38 MM / FORMAT AVAILABLE IN 38X38 MM

* REFERENCIAS DISPONIBLES EN ACABADO ANTIDESLIZANTE
 * AVAILABLE REFERENCES IN ANTISLIP FINISHED
 * RÉFÉRENCES DISPONIBLES EN FINITIONS ANTIDÉRAPANTES



FORMATO - SIZE	PLACA SHEET PLAQUE			CAJA BOX CAISSE			PALET PALLET PALETTE		
	PIEZAS PIECES	MEDIDA DIMENSIONS	KGS KGS	PLACAS SHEET	M ² SQM	KGS KGS	CAJAS BOXES	M ² SQM	KGS KGS
25x25 MM	144	315x315	0,90	20	2	18	63	126	1.134,00
25x25 MM PUNTOS	180	315x396	1,13	16	2	18	72	144	1.296,00
38x38 MM	64	315x315	1,040	20	2	21,166	63	126	1348,46

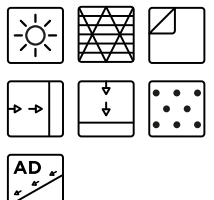



200

111 / 750 COLORS+ AGUAMARINA



COLOR+ COLLECTION

Ante la necesidad de ofrecer a nuestros clientes un producto cada vez más diferencial, destinado principalmente a piscinas, baños o zonas húmedas, Vidrepur ha desarrollado unas mezclas formadas con la colección colors y con destellos de titanium para otorgar así mayor valor añadido. Las mezclas de la serie colors plus, pueden hacer que una piscina ofrezca una apariencia más atractiva, y luminosa.

With the need to offer our clients an ever more differentiated product, particularly for swimming pools, bathrooms and other wet areas, Vidrepur has developed a mix made up of the colors collection with flashes of titanium, so we can offer better added value.

A mix of the colors plus series can give a pool a more attractive and light appearance

Afin de pouvoir offrir à nos clients un produit de plus en plus différencié, principalement destiné aux piscines, salles de bains ou zones humides, Vidrepur a développé des mélanges créés avec la collection colors et des éclats de titanium qui leur donnent ainsi une plus grande valeur ajoutée.

Les mélanges de la série colors plus peuvent donner à une piscine un aspect plus attrayant et lumineux.

201



202

503 / 720 COLORS+ JADE



111 / 750 COLORS+ AGUAMARINA



100 / 710 COLORS+ DIAMANTE



500 / 722 COLORS+ TOPACIO

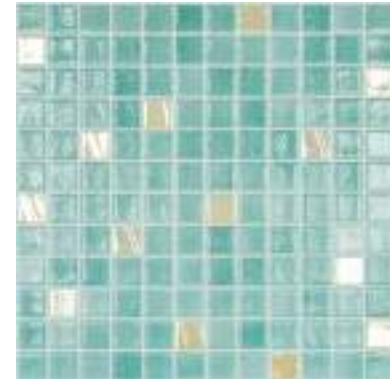

503 / 720 COLORS+ JADE

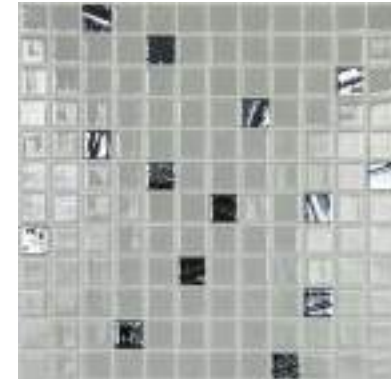

109 / 780 COLORS+ OBSIDIANA

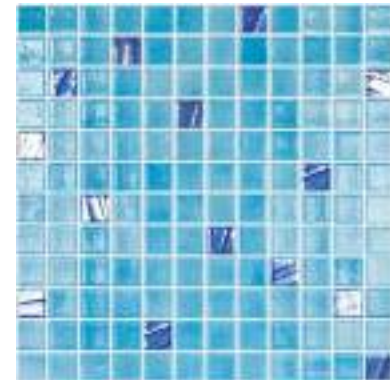

501 / 734 COLORS+ TURQUESA

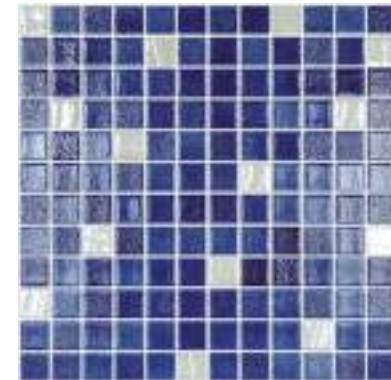

508/710 COLORS+ ZAFIRO

203

FORMATO - SIZE	PLACA SHEET PLAQUE			CAJA BOX CAISSE			PALET PALLET PALETTE		
	PIEZAS PIECES	MEDIDA DIMENSIONS	KGS KGS	PLACAS SHEET	M ² SQM	KGS KGS	CAJAS BOXES	M ² SQM	KGS KGS
25x25 MM	144	315x315	0,90	20	2	18	63	126	1.134,00

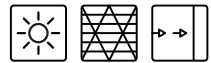



204



ANTISLIP COLLECTION

Producto antideslizante Vidrepur, la mejor solución. Material innovador, higiénico, y de fácil mantenimiento. La mejor solución para plato de ducha, baños y otras zonas húmedas como proyectos, spas, balnearios, etc...

El agua no queda estancada gracias a la nula absorción.

Es la solución perfecta para gente con incapacidad, para niños, gente de avanzada edad...

El producto antideslizante de vidrepur es la mejor opción y garantiza la mayor seguridad de nuestra familia en lugares públicos.

Además de los beneficios de seguridad e higiene tienes una amplia gama de colores y diseños para elegir.

Antislip Vidrepur, The best solution. innovate, hygenic, easy maintenace. Best solution for shower basin, bathrooms, other wet areas as spa and wellness or sport complexes etc...

Water does not stuck, thanks to the 0% water absorption.

It is the perfect solution for disabled people, also for children and older people...

The product guarantees the maximum safet for our families.

Besides of safety and hygiene... there is a wide assortment.

205

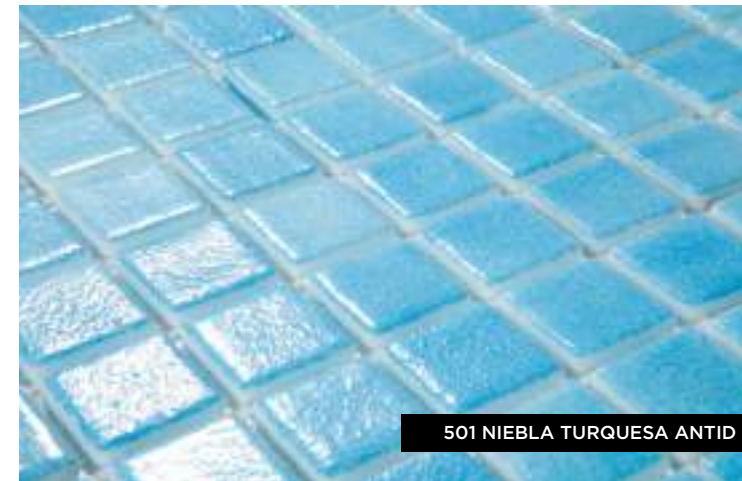

501 NIEBLA TURQUESA ANTID



100 LISO BLANCO ANTID

ACABADOS ANTIDESLIZANTES | NON-SLIP FINISHES

LAS NUEVAS NORMATIVAS INTERNACIONALES DE EDIFICACIÓN PRESTAN ESPECIAL ATENCIÓN A LA SEGURIDAD FRENTE AL RIESGO DE CAÍDAS.

VIDREPUR, SIEMPRE EN CONSTANTE EVOLUCIÓN, HA DESARROLLADO UNA COMPLETA GAMA DE PRODUCTOS ANTIDESLIZANTES QUE GARANTIZAN LA MÁXIMA SEGURIDAD Y QUE ADEMÁS CUMPLEN CON TODAS LAS EXIGENCIAS DESCRITAS EN LAS NORMATIVAS, SIN POR ELLO RENUNCIAR A LA EXTENSA GAMA DE COLORES QUE NOS DIFERENCIA.

OFRECEMOS DOS TIPOS DE ACABADOS ANTIDESLIZANTES QUE DAN SOLUCIÓN A TODO TIPO DE NECESIDADES.

NEW INTERNATIONAL BUILDING STANDARDS AND CODES PLACE SPECIAL EMPHASIS ON THE PREVENTION OF SLIP AND FALL HAZARDS.

AS PART OF ITS CONTINUOUS DEVELOPMENT OF THE NEW PRODUCTS, VIDREPUR HAS DEVELOPED A COMPLETE RANGE ANTI-SLIP PRODUCTS WHICH GUARANTEE MAXIMUM SAFETY AND MEET ALL NORMATIVE REQUIREMENTS WHILE OFFERING THE SAME EXTENSIVE RANGE OF COLOURS CLIENTS HAVE COME TO EXPECT FROM VIDREPUR.

WE OFFER 2 TYPES OF ANTI-SLIP SURFACE WHICH CAN MEET ANY REQUIREMENTS.

ACABADOS Y CARACTERÍSTICAS | FINISHES AND CHARACTERISTICS

ICONO ICON	ACABADO FINISH	SUPERFICIE SURFACE	COLOR ORIGINAL ORIGINAL COLOUR	GRADO DE MANTENIMIENTO (2) DEGREE OF MAINTENANCE (2)
	ANTIDESLIZANTE CLASE 2 NON SLIP CLASS 2	SATINADA Y SUAVE AL TACTO SMOOTH ON TOUCH	NO SE ALTERA DOESN'T CHANGE	2
	ANTIDESLIZANTE CLASE 3 NON SLIP CLASS 3	MATE Y SUAVE AL TACTO MATT AND SMOOTH ON TOUCH	EN SECO: EL COLOR ORIGINAL SE VE ALTERADO (1) EN MOJADO: RECUPERA EL COLOR ORIGINAL DRY: THE ORIGINAL COLOUR CHANGES (1) WET: IT REGAINS ITS ORIGINAL COLOUR	3

(1) CUANTO MÁS CLARO ES EL COLOR ORIGINAL, MENOS SE APRECIA ESTE CAMBIO DE TONO

(2) PARA CONSEGUIR UN ACABADO ANTIDESLIZANTE ES NECESARIO AUMENTAR LA MICRORRUGOSIDAD DE LA SUPERFICIE.

A MAYOR MICRORRUGOSIDAD, MAYOR ES EL GRADO DE ANTIDESLIZAMIENTO, PERO AUMENTA EL GRADO DE MANTENIMIENTO DEL PRODUCTO.

(1) THE LIGHTER THE ORIGINAL COLOUR, THE LESS THIS CHANGE IN TONE IS NOTICEABLE

(2) IN ORDER TO ACHIEVE A SLIP-RESISTANCE SURFACE, THE MICRO-ROUGHNESS OF THE SURFACE MUST BE AUGMENTED. THE GREATER THE MICRO-ROUGHNESS THE GREATER THE SLIP RESISTANCE BUT THIS ALSO INCREASE THE DEGREE OF MAINTENANCE REQUIRED.

ELECCIÓN DEL ACABADO CORRECTO | THE CHOICE OF THE CORRECT FINISHES

A LA HORA DE ELEGIR UN MATERIAL ANTIDESLIZANTE HAY QUE TENER EN CUENTA DOS ASPECTOS:

- **LA NORMA APLICABLE:** ESTABLECE LA CLASE MÍNIMA QUE HA DE USARSE EN DETERMINADA SUPERFICIE EN FUNCIÓN DEL USO QUE SE LE VAYA A DAR. EL USUARIO PUEDE UTILIZAR LA CLASE INDICADA O UNA SUPERIOR.

- **MANTENIMIENTO Y LIMPIEZA:** LA SUPERFICIE DEL MOSAICO TRADICIONAL ES TOTALMENTE LISA, NO PRESENTA RUGOSIDADES, Y POR LO TANTO, ES MUY SENCILLO DE MANTENER Y LIMPIAR. SIN EMBARGO PARA CONSEGUIR SUPERFICIES ANTIDESLIZANTES, ES NECESARIO AUMENTAR LA MICRORRUGOSIDAD DE LAS MISMAS. A MAYOR MICRORRUGOSIDAD SE INCREMENTA TANTO EL GRADO DE DESLIZAMIENTO COMO EL GRADO DE MANTENIMIENTO Y LIMPIEZA DEL MOSAICO.

WHEN CHOOSING ANTI-SLIP MATERIALS, TWO ASPECTS MUST BE TAKEN INTO ACCOUNT:

- **APPLICABLE STANDARDS:** THIS ESTABLISHES THE MINIMUM CLASS TO BE USED ON THE SURFACE ACCORDING TO THE TYPE OF USE. THE USER MAY CHOOSE THE CLASS INDICATED OR ONE SUPERIOR.

- **MAINTENANCE AND CLEANING:** THE SURFACE OF TADITIONAL MOSAIC TILES IS COMPLETELY SMOOTH, WITHOUT ROUGHNESS, AND IS THEREFORE VERY EASY TO MAINTAIN AND KEEP CLEAN. HOWEVER, FOR SLIP RESISTANT SURFACES, IT IS NECESSARY TO AUGMENT THE MICRO-ROUGHNESS OF THE TILES.

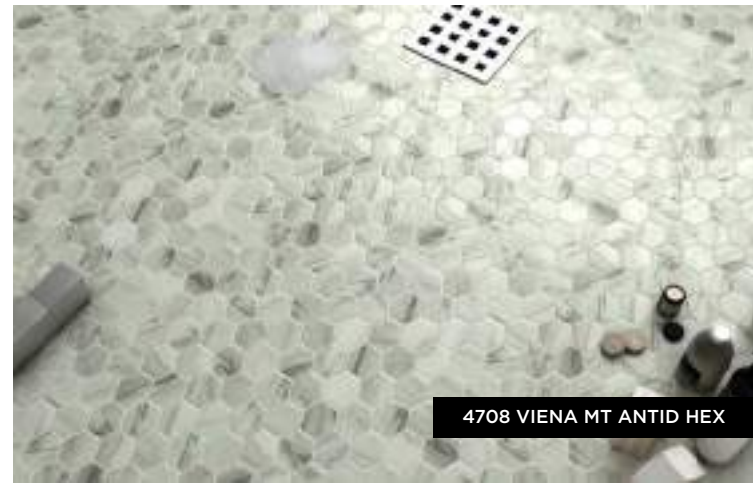

908 NORDIC DARK GREY MT ANTID HEX

4708 VIENA MT ANTID HEX

ACABADOS ANTIDESLIZANTES | NON-SLIP FINISHES

NORMA UNE - ENV 12633:2003 ENSAYO: VALOR MEDIO (USRV) 91 (CLASE 3)
STANDARD UNE - ENV 12633:2003 TEST: PENDULUM TEST AVERAGE VALUE (USRV) 91 (CLASS 3)

CLASIFICACIÓN DE LOS SUELOS SEGÚN SU RESBALADIDAD		
RESISTENCIA AL DESLIZAMIENTO (RD)	CLASE	CLASE MÍNIMA EXIGIDA EN LOS SUELOS SEGÚN LOCALIZACIÓN: ZONAS
$R_d \leq 15$	CLASE 0	
$15 < R_d \leq 35$	CLASE 1	INTERIORES SECAS: SUPERFICIES CON PENDIENTE MENOR A 6%
$35 < R_d \leq 45$	CLASE 2	INTERIORES SECAS: SUPERFICIES CON PENDIENTE IGUAL O SUPERIOR A 6 Y ESCALERAS INTERIORES HÚMEDAS (1): SUPERFICIES CON PENDIENTE MENOR A 6%
$R_d > 45$	CLASE 3	INTERIORES HÚMEDAS (1): SUPERFICIES CON PENDIENTE IGUAL O SUPERIOR A 6% Y ESCALERAS EXTERIORES PISCINAS (2)
(1) TALES COMO TERRAZAS CUBIERTAS, VESTUARIOS, DUCHAS, BAÑOS, COCINAS. ZONAS INTERIORES DONDE ADEMÁS DE AGUA PUEDE EXISTIR CONTACTO CON LUBRICANTES, JABÓN O ACEITES QUE REDUZCAN LA RESISTENCIA AL DESLIZAMIENTO. (2) ZONAS DESTINADAS A USUARIOS DESCALZOS Y FONDOS DE VASOS DE PISCINAS DONDE LA PROFUNDIDAD NO EXCEDA DE 1,50 M.		
RESULTADOS MOSAICO VIDREPUR		
CLASE 1 CLASE 2 CLASE 3		

CLASSIFICATION OF FLOORS ACCORDING TO THEIR SLIPPERINESS		
RESISTENCIA AL DESLIZAMIENTO (RD)	CLASS	MINIMUM CLASS REQUIRED FOR FLOORS ACCORDING TO LOCATION: ZONES
$RD \leq 15$	CLASS 0	
$15 < RD \leq 35$	CLASS 1	DRY INTERIORS: SURFACES WITH A SLOPE LESS THAN 6%
$35 < RD \leq 45$	CLASS 2	DRY INTERIORS: SURFACES WITH A SLOPE GREATER THAN OR EQUAL TO 6% AND STAIRS WET INTERIORS (1): SURFACES WITH A SLOPE LESS THAN 6%
$RD > 45$	CLASS 3	WET INTERIORS (1): SURFACES WITH A SLOPE GREATER THAN OR EQUAL TO 6% AND STAIRS EXTERIOR POOLS (2)
(1) SUCH AS COVERED TERRACES, CHANGE ROOMS, BATHROOMS AND KITCHENS. INTERIOR AREAS WHERE WATER MAY BE PRESENT IN CONJUNCTION WITH LUBRICANTS, SOAP OR OILS WHICH REDUCE SLIP RESISTANCE. (2) BAREFOOT AREAS AND THE BOTTOMS OF SWIMMING POOLS WITH A DEPTH OF LESS THAN 1,50 M.		
RESULTS FOR VIDREPUR MOSAIC		
CLASS 1 CLASS 2 CLASS 3		

NORMATIVAS INTERNACIONALES













NORMA ISO/DIS 10545-17 METODO TORTUS	NORMA DIN 51097:1992 PIE DESCALZO	NORMA DIN 51130:2014 PIE CALZADO
EL MÉTODO TORTUS, SE REALIZA CON UN APARATO MECÁNICO QUE SE DESPLAZA A VELOCIDAD CONSTANTE SOBRE LA SUPERFICIE A ESTUDIAR. ESTE APARATO INDICA EL COEFICIENTE DE ROZAMIENTO DURANTE SU DESPLAZAMIENTO. LAS MEDIDAS SE REALIZAN EN CONDICIONES DE PAVIMENTO SECO O MOJADO.	MIDE LAS PROPIEDADES ANTIDERRAPANTES PARA ZONAS EN LAS QUE SE CAMINA DESCALZO. EL ENSAYO SE REALIZA EN UN DISPOSITIVO EN EL QUE LA PERSONA QUE EFECTÚA EL ENSAYO CAMINA SOBRE UN PLANO INCLINADO DE PENDIENTE VARIABLE. LA SUPERFICIE VA REVESTIDA CON LAS BALDOSAS A ENSAYAR Y ESTÁ CONSTANTEMENTE IMPREGNADA DE UNA SOLUCIÓN JABONOSA. EL ÁNGULO DEL PLANO INCLINADO QUE TODAVÍA PERMITE ESTAR DE PIE CON SEGURIDAD, ES LA MEDIDA DE ENSAYO	DESCRIBE EL MÉTODO DE DETERMINACIÓN DE LAS PROPIEDADES ANTIDERRAPANTES DE LOS PAVIMENTOS UTILIZADOS EN LOS LUGARES DONDE SE TRANSITA CON PIE CALZADO. ESTE ENSAYO SE REALIZA EN UN DISPOSITIVO EN EL QUE LA PERSONA QUE EFECTÚA LA PRUEBA, CAMINA SOBRE UN PLANO INCLINADO DE ÁNGULO VARIABLE CON PIE CALZADO DE SUELA NORMALIZADA. LA SUPERFICIE ESTÁ CONTINUAMENTE IMPREGNADA CON UN AGENTE LUBRICANTE (ACEITE PARA MOTOR SAEIOW30). EL ÁNGULO DEL PLANO INCLINADO QUE TODAVÍA PERMITE ESTAR DE PIE CON SEGURIDAD, SIN DESLIZARSE, ES LA MEDIDA DE ENSAYO
CLASIFICACIÓN DE LOS MATERIALES SEGÚN LOS RESULTADOS DEL ENSAYO	CLASIFICACIÓN DE LOS MATERIALES SEGÚN LOS RESULTADOS DEL ENSAYO	CLASIFICACIÓN DE LOS MATERIALES SEGÚN LOS RESULTADOS DEL ENSAYO
ISO/DIS 10545-17 TORTUS VALOR MEDIO (μ) $\mu \leq 0,20$: PELIGROSO $0,20 < \mu \leq 0,40$: MARGINAL $0,40 < \mu \leq 0,75$: SATISFACTORIO $\mu > 0,75$: EXCELENTE	DIN 51097 - ÁNGULO DE INCLINACIÓN TOTAL MEDIO CLASE A $\geq 12\%$ CLASE B $\geq 18\%$ CLASE C $\geq 24\%$	DIN 51130 - ÁNGULO DE ACEPTACION TOTAL MEDIO R9 $6^\circ \leq a_{TOT} \leq 10^\circ$ R10 $10^\circ < a_{TOT} \leq 19^\circ$ R11 $19^\circ < a_{TOT} \leq 27^\circ$ R12 $27^\circ < a_{TOT} \leq 35^\circ$ R13 $35^\circ < a_{TOT}$
COEFICIENTE DE FRICCIÓN DINÁMICO MEDIO	ÁNGULO DE INCLINACIÓN TOTAL MEDIO	ENSAYO ÁNGULO CRÍTICO DE DESLIZAMIENTO
EXCELENTE EN SECO = 0,88 EXCELENTE EN HUMEDO = 0,83	CLASE C ($>38^\circ$)	R13 ($>36,3^\circ$)

INTERNATIONAL STANDARDS

STANDARD ISO/DIS 10545-17 TORTUS METHOD	STANDARD DIN 51097 SLIP RESISTANCE BAREFOOT	STANDARD DIN 51130 SLIP RESISTANCE FOOTWEAR
THE TORTUS TEST IS PERFORMED USING A MECHANICAL DEVICE WHICH MOVES AT A CONSTANT SPEED OVER THE TESTED SURFACE. THE DEVICE INDICATES THE SLIPPAGE COEFFICIENT DURING MOVEMENT. THE MEASUREMENTS TAKEN IN BOTH WET AND DRY CONDITIONS.	THIS MEASURES THE ANTI-SLIP PROPERTIES FOR AREAS WHERE PEDESTRIAN WALK BAREFOOT. THE TEST IS PERFORMED USING A DEVICE WHERE A PERSON WALKS ON A SURFACE WITH A VARIABLE INCLINE. THE SURFACE IS COVERED WITH THE TILES TO BE TESTED AND CONSTANTLY IMPREGNATED WITH A SOAPY SOLUTION. THE TEST MEASURES THE ANGLE OF INCLINATION AT WHICH A PERSON MAY STAND SAFELY.	THIS DESCRIBES THE METHOD TO DETERMINE THE ANTI-SLIP PROPERTIES OF SURFACES USING IN AREAS WHERE PEDESTRIANS WALK WITH FOOTWEAR. THE TEST IS PERFORMED USING A DEVICE WHERE A PERSON WALKS ON A SURFACE WITH A VARIABLE INCLINE WITH NORMAL SOLED FOOTWEAR. THE SURFACE IS COVERED WITH THE TILES TO BE TESTED AND CONSTANTLY IMPREGNATED WITH A LUBRICANT (SAE IOW30 MOTOR OIL). THE TEST MEASURES THE ANGLE OF INCLINATION AT WHICH A PERSON MAY STAND SAFELY WITHOUT SLIPPING.
CLASSIFICATION OF MATERIALS ACCORDING TO TEST RESULTS	CLASSIFICATION OF MATERIALS ACCORDING TO TEST RESULTS	CLASSIFICATION OF MATERIALS ACCORDING TO TEST RESULTS
ISO/DIS 10545-17 TORTUS AVERAGE VALUE (μ) $\mu \leq 0,20$: DANGEROUS $0,20 < \mu \leq 0,40$: MARGINAL $0,40 < \mu \leq 0,75$: SATISFACTORY $\mu > 0,75$: EXCELLENT	DIN 51097 - AVERAGE TOTAL ANGLE OF INCLINATION CLASS A $\geq 12\%$ CLASS B $\geq 18\%$ CLASS C $\geq 24\%$	DIN 51130 - ANGLE OF INCLINATION R9 $6^\circ - 10^\circ$ R10 $10^\circ - 19^\circ$ R11 $19^\circ - 27^\circ$ R12 $27^\circ - 35^\circ$ R13 $> 35^\circ$
AVERAGE DYNAMIC COEFFICIENT OF FRICTION	AVERAGE TOTAL ANGLE OF INCLINATION	AVERAGE TOTAL ACCEPTANCE ANGLE
EXCELLENT FOR DRY SURFACE = 0,88 EXCELLENT FOR WET SURFACE = 0,83	CLASS C ($> 38^\circ$)	R13

ANSI A137.1:2017		
ENSAYO COEFICIENTE DE FRICCIÓN DINÁMICO (DCOF)	0,76	
AVERAGE DYNAMIC COEFFICIENT OF FRICTION (DCOF)	0,76	

ESPECIFICACIONES TÉCNICAS | TECHNICAL SPECIFICATIONS

SÍMBOLO SYMBOL SYMBOLO	CARACTERÍSTICA TÉCNICA TECHNICAL CHARACTERISTIC	NORMA DE ENSAYO TEST STANDARD	REQUISITOS EXIGIDOS POR DEMANDED REQUIREMENTS UNE/EN 14411 ISO 13006	CUMPLIMIENTO POR VIDREPUR VIDREPUR RESPONDS
	ABSORCIÓN DE AGUA (E) WATER ABSORPTION (E)	UNE-EN ISO 10545:3	BLA GRUPO E ≤ 0.5% BLA GROUP E ≤ 0.5%	E ≤ 0.1 %
	RESISTENCIA A LA ABRASIÓN PROFUNDA RESISTENCIA A LA ABRASIÓN PROFUNDA	UNE-EN ISO 10545:6 GUÍA DE LA BALDOSA CERÁMICA CERAMIC TILES GUIDE	393 MM ³ TIPO 5 TIPO DE PAVIMENTO DE TRÁNSITO PEATONAL TYPE 5: FOR USE IN HIGH PEDESTRIAN TRAFFIC AREAS	215 MM ³
	RESISTENCIA AL CHOQUE TÉRMICO REISTANCE TO THERMAL SHOCK	UNE-EN ISO 10545:9	MÉTODO DE ENSAYO DISPONIBLE TEST METHOD AVAILABLE	RESISTE RESIST RÉSISTER
	RESISTENCIA A LA HELADA FROST RESISTANCE	UNE-EN ISO 10545:12	EXIGIDO REQUIRED	RESISTE RESIST
	RESISTENCIA A LOS PRODUCTOS QUÍMICOS (BAJAS CONCENTRACIONES) RESISTANCE TO CHEMICALS (LOW CONCENTRATIONS)	UNE-EN ISO 10545:13	SEGÚN LO QUE ESPECIFIQUE EL FABRICANTE ACCORDING TO MANUFACTURE'S CLASSIFICATION	ULA
	RESISTENCIA A LOS PRODUCTOS QUÍMICOS DE USO DOMÉSTICO Y SALES PARA PISCINAS RESISTANCE TO HOUSEHOLD CHEMICALS AND SWIMMING POOL SALTS	UNE-EN ISO 10545:13	MÍNIMO: UB MINIMUM: UB	UA
	RESISTENCIA A LAS MANCHAS STAIN RESISTANCE	UNE-EN ISO 10545:14	CLASE ≥ 3 CLASS ≥ 3	CLASE 5 CLASS 5
	RESISTENCIA AL RAYADO (MOHS) SCRATCH HARDNESS	EN-UNE 101:1991	MÍNIMO: 6 MINIMUM: 6	6
	RESISTENCIA AL DESLIZAMIENTO (PÉNDULO) SLIP RESITANCE (PENDULUM)	UNE-ENV 12633:2003	NO EXIGIDO NOT REQUIRED	USRV = 50 = CLASE 3 USRV = 50 = CLASS 3
	MÉTODO TORTUS TORTUS METHOD	ISO/DIS 10545-17	NO EXIGIDO NOT REQUIRED	FS = 0,84 FH = 0,80 EXCELENTE
	RESISTENCIA AL DESLIZAMIENTO PIE DESCALZO SLIP RESISTANCE (BAREFOOT)	DIN 51097:1992	NO EXIGIDO NOT REQUIRED	CLASE C > 24° CLASS C > 24°
	RESISTENCIA AL DESLIZAMIENTO PIE CALZADO SLIP RESISTANCE (WEARING SHOES)	DIN 51130:2004	NO EXIGIDO NOT REQUIRED	30,2° = R12



FORMATO - SIZE	PLACA SHEET PLAQUE			CAJA BOX CAISSE			PALET PALLET PALETTE		
	PIEZAS PIECES	MEDIDA DIMENSIONS	KGS KGS	PLACAS SHEET	M ² SQM	KGS KGS	CAJAS BOXES	M ² SQM	KGS KGS
25x25 MM	144	315x315	0,90	20	2	18	63	126	1,134
35x35 MM	99	317x307	0,99	10	0,87	9,93	126	109,62	1.251,18

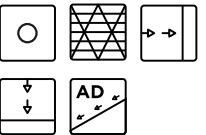

NORMAS DE REFERENCIA: UNE-EN 14411 ISO 13006. BALDOSAS CERÁMICAS. DEFINICIONES, CLASIFICACIÓN, CARACTERÍSTICAS Y MARCADO.
REFERENCE STANDARD: UNE-EN 14411 ISO 13006. CERAMIC TILES. DEFINITIONS, CLASSIFICATION, CHARACTERISTICS AND MARKING.



TECHNOCLEAN

BY VIDREPUR

ES LA SÍNTESIS DE AÑOS DE EMPEÑO Y SENSIBILIDAD POR PARTE DE VIDREPUR EN MATERIA DE ECOSOSTENIBILIDAD.

COMMITMENT TO THE ENVIRONMENT TECHNOCLEAN BY VIDREPUR IS THE ONLY GLASS MOSAIC ANTI-POLLUTION AND BACTERICIDAL.

C'EST LA SYNTHÈSE DE LA PERSÉVÉRANCE ET DE LA SENSIBILITÉ DE VIDREPUR, DES ANNÉES DURANT, EN FAVEUR DE L'ÉCODURABILITÉ.

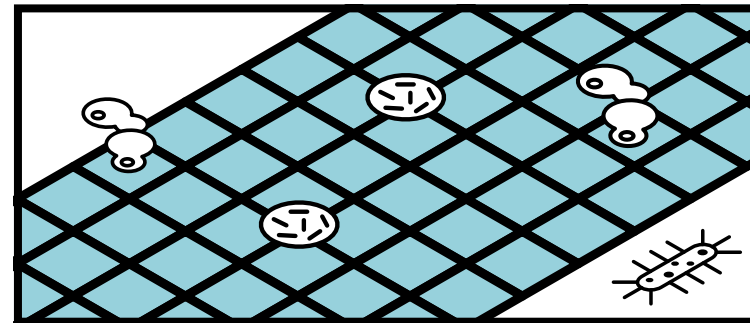
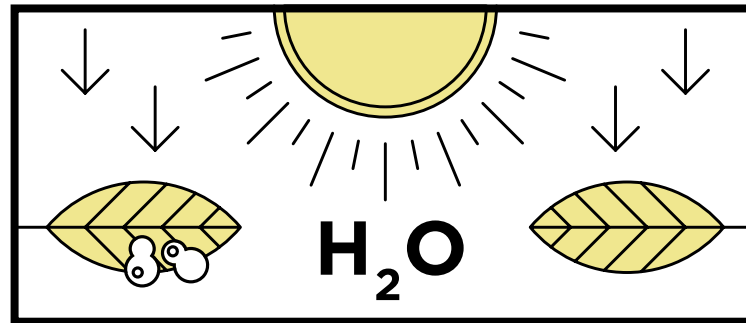

NANOCAPA CON FOTOCATÁLISIS

LA FOTOCATÁLISIS ES LA REACCIÓN QUE UTILIZA LA LUZ PARA ACTIVAR UNA SUSTANCIA. ESTA SUSTANCIA SE CONOCE COMO FOTOCATALIZADOR Y AUMENTA EL ÍNDICE DE UNA REACCIÓN REDUCIENDO EL TIEMPO Y LA ENERGÍA NECESARIAS PARA PRODUCIR DICHA REACCIÓN FOTOQUÍMICA.

LA FOTOCATÁLISIS HETEROGÉNEA ESTÁ CONSIDERADA COMO UNA DE LAS NUEVAS «TECNOLOGÍAS AVANZADAS DE OXIDACIÓN» (TAO) HABITUALMENTE USADA PARA LOS TRATAMIENTOS DE PURIFICACIÓN DE AIRE Y AGUA.

UNA SUPERFICIE FOTOCATALÍTICA, EN PRESENCIA DE UNA FUENTE DE LUZ, TIENE LAS SIGUIENTES PROPIEDADES.

- SUPERHIDRÓFILA / AUTO LIMPIABLE.
- ANTI BACTERIANA Y ANTIVÍRICA
- ANTI HONGOS, ANTI MUSGOS.
- DESODORIZANTE.
- ANTIESTÁTICO, ANTI POLVO.
- PROTECCIÓN UV.
- DESCONTAMINACIÓN AMBIENTAL

PHOTOCATALYSIS

PHOTOCATALYSIS IS A REACTION WHICH USES LIGHT TO ACTIVATE A SUBSTANCE. THIS SUBSTANCE, KNOWN AS A PHOTOCATALYST, INCREASES THE REACTION RATE BY REDUCING THE TIME AND ENERGY REQUIRED FOR THE PHOTOCHEMICAL REACTION.

HETEROGENEOUS PHOTOCATALYSIS IS CONSIDERED ONE OF THE NEW "ADVANCED OXIDATION TECHNOLOGIES" (AOT), COMMONLY USED FOR AIR AND WATER PURIFICATION TREATMENTS.

A PHOTOCATALYTIC SURFACE, IN THE PRESENCE OF A LIGHT SOURCE, HAS THE FOLLOWING PROPERTIES.

- SUPERHYDROPHILIC / SELF-CLEANING.
- ANTIBACTERIAL AND ANTIVIRAL.
- ANTIFUNGAL, ANTI-MOSS.
- DEODORISING.
- ANTISTATIC, ANTI-DUST.
- UV PROTECTION.
- ENVIRONMENTAL DECONTAMINATION.

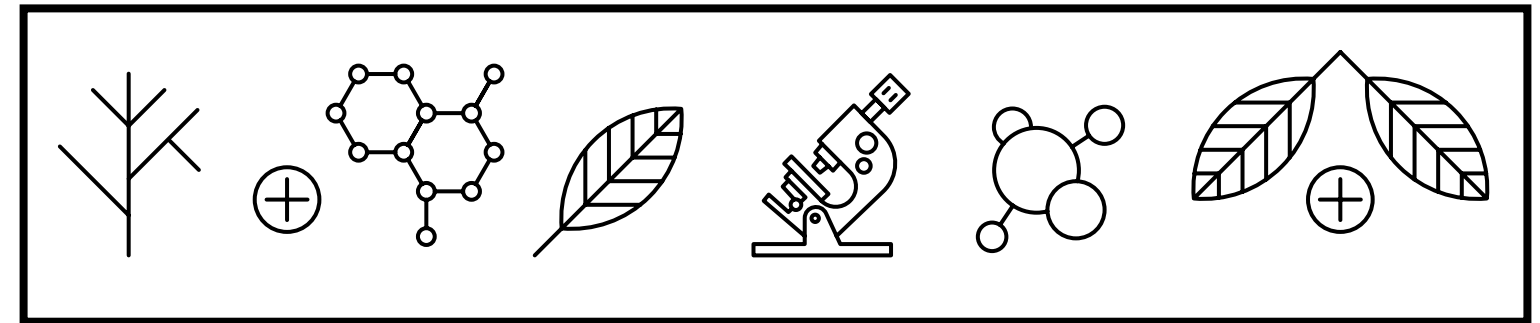

NANO-COUCHE AVEC PHOTOCATALYSE

LA PHOTOCATALYSE EST LA RÉACTION INITIÉE PAR LA LUMIÈRE POUR ACTIVER UNE SUBSTANCE. CETTE SUBSTANCE EST CONNUE COMME PHOTOCATALYSEUR ET AUGMENTE L'INDICE D'UNE RÉACTION PHOTOCHEMIQUE.

LA PHOTOCATALYSE HÉTÉROGÈNE EST CONSIDÉRÉE L'UNE DES «TECNOLOGIES D'OXIDATION AVANÇÉES» (TAO) NORMALEMENT UTILISÉE POUR LES TRAITEMENTS DE PURIFICATION DE L'AIR ET DE L'EAU.

EN PRÉSENCE D'UNE SOURCE DE LUMIÈRE, UNE SURFACE PHOTOCATALYTIQUE PRÉSENTE LES PROPRIÉTÉS SUIVANTES.

- SUPERHYDROPHILE /AUTOLAVABLE.
- ANTIBACTÉRIENNE ET ANTIVIRAL.
- ANTI-CHAMPIGNONS /ANTI-MOISSURES.
- DÉSODORISANTE.
- ANTI-STATIQUE, ANTI-POUSSIÈRE.
- PROTECTION UV.
- DÉPOLLUTION ENVIRONNANTE.



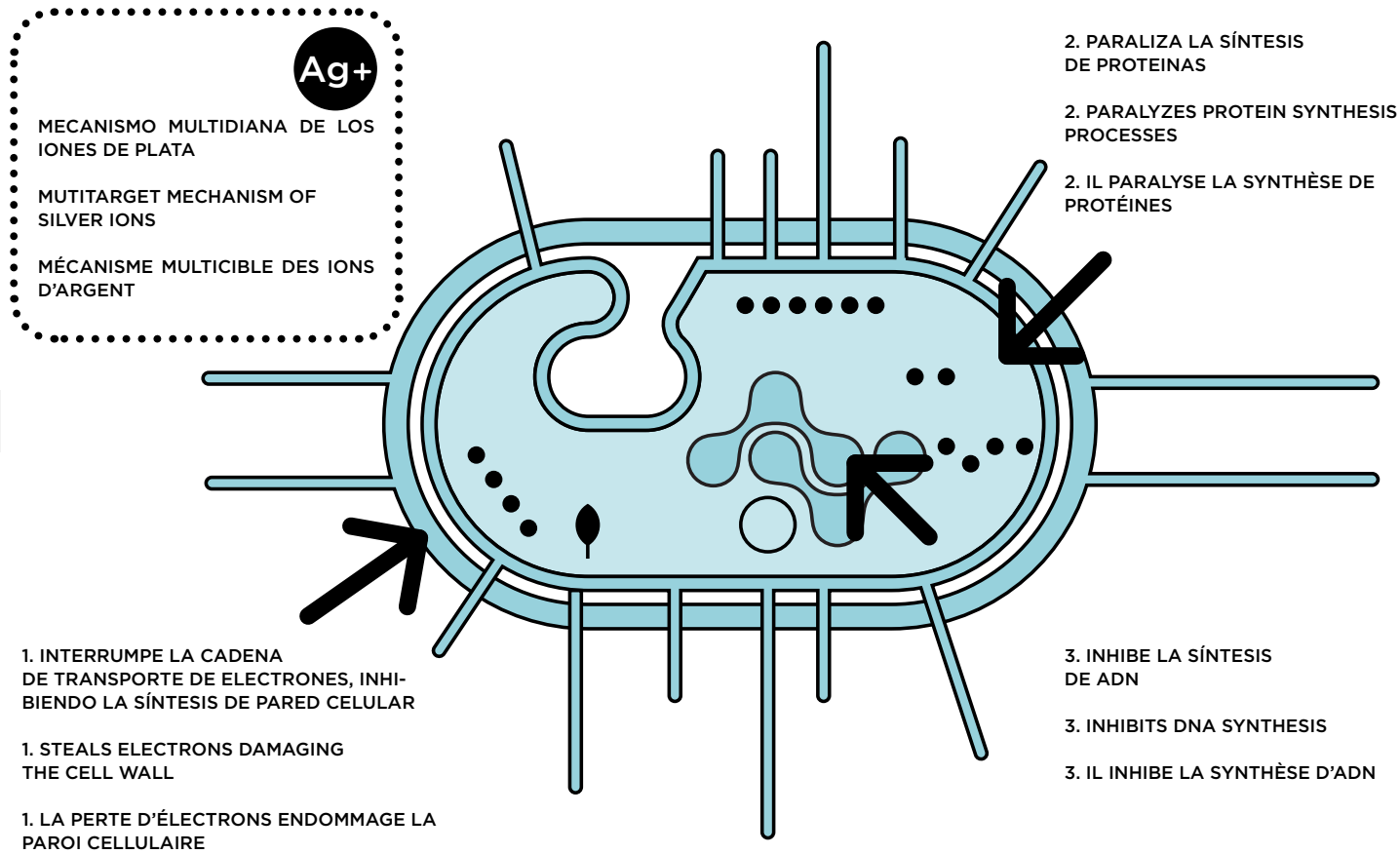

**CAPACIDAD ANTIBACTERIANA AVANZADA / HIGH ANTIBACTERIAL CAPACITY
 CAPACITÉ ANTIBACTÉRIENNE AVANCÉE**

LA NANOCAPA **TECHNOCLEAN** TIENE UNA CAPACIDAD ANTIBACTERIANA MULTITIANA GRACIAS AL USO DE PLATA IÓNICA.
 THE **TECHNOCLEAN** NANO-COATING HAS A MULTI-TARGET ANTIBACTERIAL CAPACITY THANKS TO THE USE OF IONIC SILVER.
 LA NANO-COUCHE **TECHNOCLEAN** POSSÈDE UNE CAPACITÉ ANTIBACTÉRIENNE MULTICIBLE GRÂCE À L'UTILISATION D'ARGENT IONIQUE.



SOLUCIÓN: MOSAICO VÍTREO AUTOLIMPIABLE

LA NANOCAPA FOTOCATALÍTICA SE APLICA FÁCILMENTE EN LA SUPERFICIE EXTERIOR DEL MOSAICO VÍTREO CARACTERÍSTICAS DIVERSIFICADAS A SUS SUPERFICIES COMO LA PROTECCIÓN ANTIUV Y LA AUTOLIMPIEZA. LA NANOCAPA OFRECERÁ A A PISCINA UN BUEN ASPECTO CON REDUCCIÓN DE LA NECESIDAD DE LIMPIEZA Y MANTENIMIENTO.

SOLUTION: SELF-CLEANING MOSAIC



THE PHOTOCATALYTIC NANOCOATING IS EASILY APPLIED TO THE OUTER SURFACE OF THE VITREOUS MOSAIC, WITH A RANGE OF PROPERTIES INCLUDING UV PROTECTION AND SELF-CLEANING. THE NANOCOATING WILL MAKE THE SWIMMING POOL LOOK GREAT AND REDUCE THE NEED FOR CLEANING AND MAINTENANCE.

SOLUTION: MOSAÏQUE EN VERRE AUTOLAVABLE

LA NANO-COUCHE PHOTOCATALYTIQUE S'APPLIQUE FACILEMENT SUR LA SURFACE EXTÉRIEURE DE LA MOSAÏQUE EN VERRE CARACTÉRISTIQUES DIVERSIFIÉES SUR LES SURFACES COMME LA PROTECTION ANTI-UV ET L'AUTONETTOYAGE. LA NANO-COUCHE OFFRE AUX PISCINES UN BEL ASPECT TOUT EN RÉDUISANT LEUR ENTRETIEN ET NETTOYAGE.

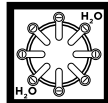
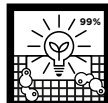

**VENTAJAS DE LA TECNOLOGIA TECHNOCLEAN / ADVANTAGES OF TECHNOCLEAN TECHNOLOGY
 AVANTAGES DE LA TECHNOLOGIE AQUATECH**

-  1. GENERA FOTOCATÁLISIS CON CUALQUIER TIPO DE LUZ
 1. PHOTOCATALYSIS GENERATION WITH ANY TYPE OF LIGHT
 1. ELLE GÉNÈRE DE LA PHOTOCATLYSE AVEC TOUT TYPE DE LUMIÈRE
-  2. EVITA LA PROLIFERACION DE ALGAS Y MUSGOS
 2. PREVENTION OF ALGAE AND MOSS PROLIFERATION
 2. ELLE ÉVITE LA PROLIFÉRATION D'ALGUES ET DE MOISSURES
-  3. DEPURA EL AIRE DE CLORAMINAS Y OTROS GASES MOLESTOS
 3. PURIFIES AIR OF CHLORAMINES AND OTHER IRRITATING GASES
 3. ELLE DÉPURE L'AIR DE CHLORAMINES ET D'AUTRES GAZ GÉNANTS
-  4. CAPACIDAD ANTIBACTERIANA PROLONGADA, INCLUSO SIN LUZ
 4. LONG-LASTING ANTIBACTERIAL CAPACITY, EVEN WITHOUT LIGHT
 4. CAPACITÉ ANTIBACTÉRIENNE PROLONGÉE, MÊME SANS LUMIÈRE



OBJETIVO

PURIFICACIÓN DEL AIRE EXTERIOR (DESCONTAMINACIÓN DE LA POLUCIÓN DE LA AUTOMOCIÓN E INDUSTRIA, COV.)
 INTERIOR PURIFICACIÓN DEL AIRE, COV, TABACO...
 DISPOSITIVOS DE PURIFICACIÓN DEL AIRE Y FILTROS INDUSTRIALES

OBJECTIVE

PURIFICATION OF OUTSIDE AIR (DECONTAMINATION OF AUTOMOTIVE AND INDUSTRIAL POLLUTION, VOCS)
 PURIFICATION OF INDOOR AIR, VOCS, TOBACCO...
 AIR PURIFICATION DEVICES AND INDUSTRIAL FILTERS

OBJECTIF

PURIFICATION DE L'AIR EXTÉRIEUR (DÉPOLLUTION DU TRAFIC ROUTIER ET DE L'INDUSTRIE, COV.)
 PURIFICATION DE L'AIR INTÉRIEUR, COV, TABAC...
 DISPOSITIFS DE PURIFICATION DE L'AIR ET FILTRES INDUSTRIELS



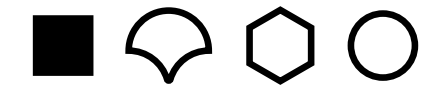

DEGRADADOS

Vidrepur cuenta con un departamento de diseño, el cuál dedica gran parte de su trabajo a realizar propuestas de combinaciones y degradados especiales para la creación de ambientes únicos.

Transiciones de colores que producen efectos de contraste y fusión.

Fade away

Vidrepur's design department dedicates a large part of its time creating proposals on special combinations and fade, to create unique moods colour transitions that produce effects of contrast and fusion.

Dégradés

Vidrepur a un département de design, ce dernier dédit une grande partie de son travail à réaliser des propositions de combinaisons et dégradés spéciaux pour la création d'ambiances uniques.

Transitions de couleurs qui produisent des effets de contraste et fusion.



DEGRADADOS COLLECTION | 25x25 MM | 1"x1" ■ ◡ ◯ ○





ARTSDECO

-  950
-  952
-  951



TEAL

-  710
-  403
-  832





LOIRE

-  710
-  750
-  733
-  734







OHIO

-  910
-  750
-  734



THAMES NEW

-  652
-  558
-  780
-  651

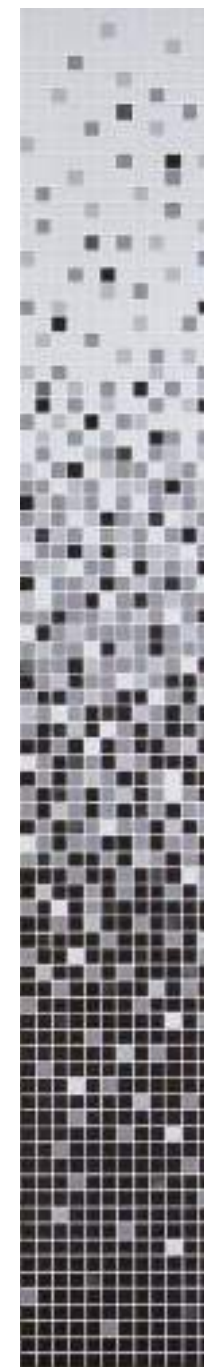
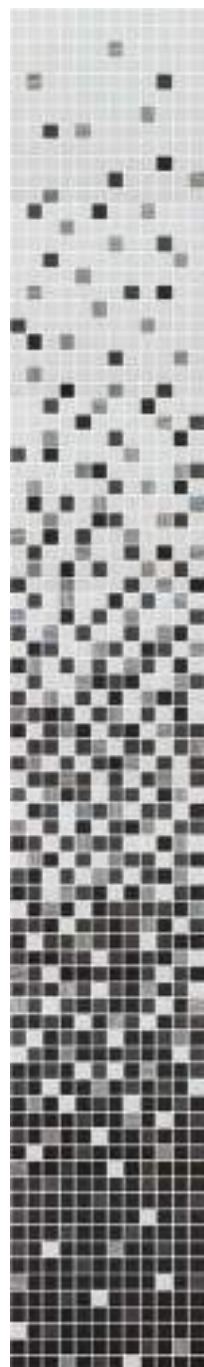
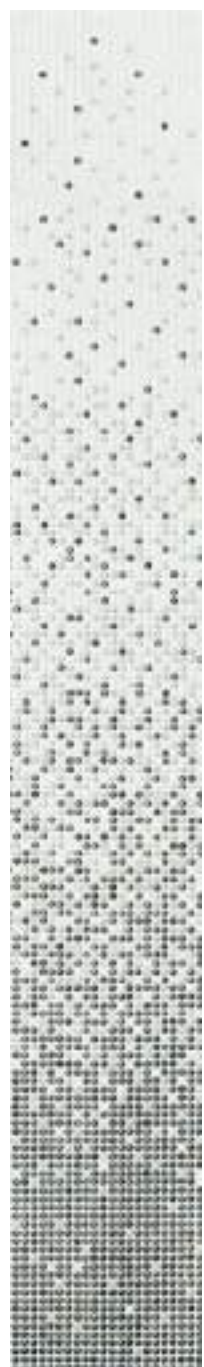

MINERAL



MIDNIGHT

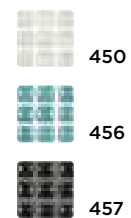

SMOKELUX NEW



IRIS



NILO



OSLO



BALI NEW



AMAZONAS NEW

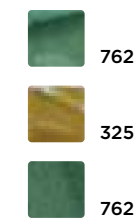

COPPER

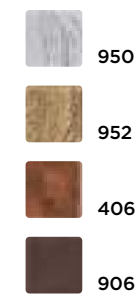

ORÁN



FORMATO / SIZE
31,5X220 CM



MEZCLAS

Geométricos

Lineas verticales, rombos y formas para decorar de forma versátil y diferente cualquier espacio y lograr ambientes únicos y confortables.

Este tipo de diseños son muy utilizados en spas, restaurantes, hoteles, piscinas, y sus dimensiones, motivos y colores armonizan cualquier zona de bienestar y ocio.

Mezclas

Explosión de color, múltiples combinaciones, posibilidades únicas de proyectos muy personales y donde el decorador o interiorista puede lograr diseños únicos.

Geometric

Vertical lines, diamond and other shapes to decorate any space in a versatile and different way, creating unique and comfortable moods.

These designs are often used in spas, restaurants, hotels and swimming pools. Their dimensions, motifs and colours harmonise any leisure or comfort area.

Mixed

Colour explosion, multiple combinations, unique possibilities for personal projects allowing the decorator or interior designer to achieve unique designs.

Géométrique

Lignes verticales, losanges et formes pour décorer de façon versatile et différente tous les espaces et obtenir des ambiances uniques et confortables.

Ce type de design est très utilisé dans les spas, restaurants, hôtels, piscines, et ses dimensions, motifs et couleurs harmonisent toutes les zones de bien-être et de loisir.

Mélanges

Explosion de couleur, multiples combinaisons, possibilités uniques de projets très personnels et où le décorateur ou interioriste peut obtenir des designs uniques.



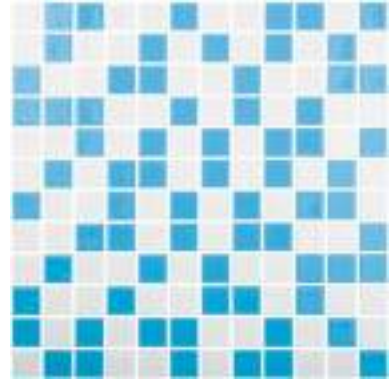

100 / 102

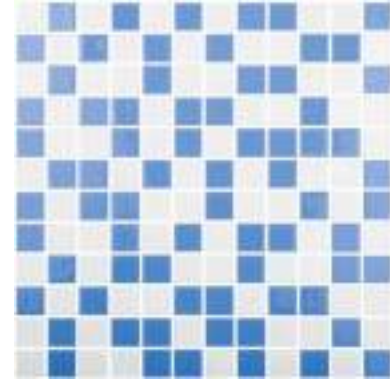

100 / 106

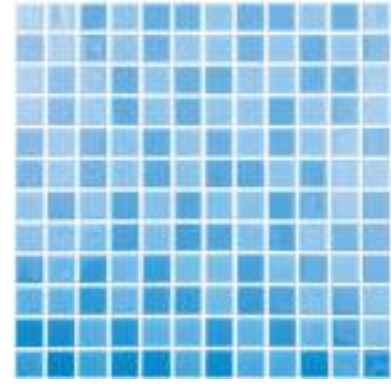

106 / 107

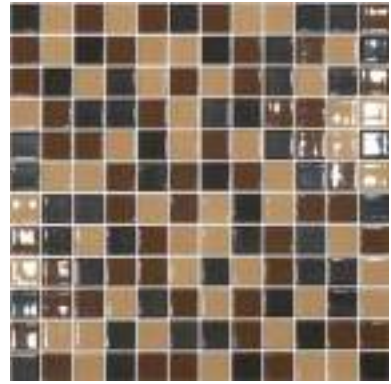

101 / 835 / 836

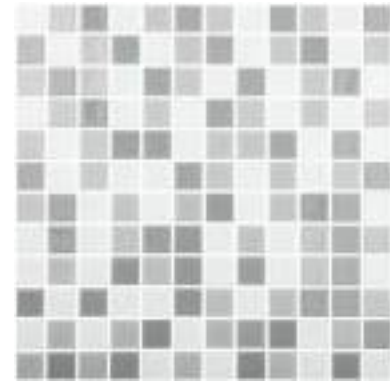

100 / 108 / 109

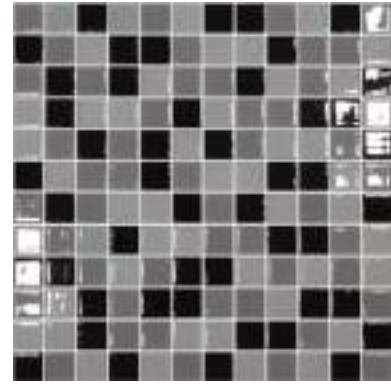

108 / 109 / 900

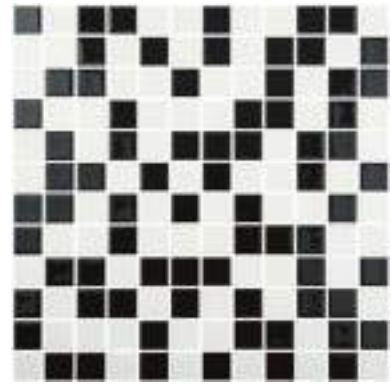

100 / 900

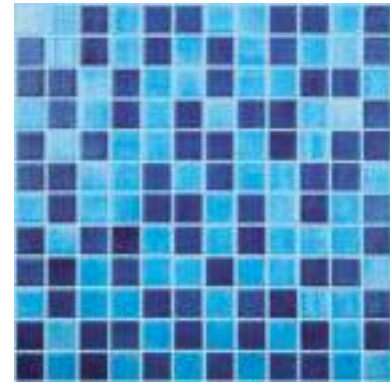

110 / 508

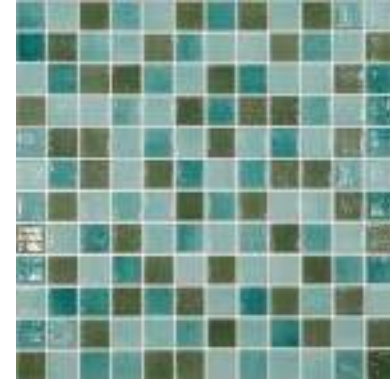

503 / 507 / 516

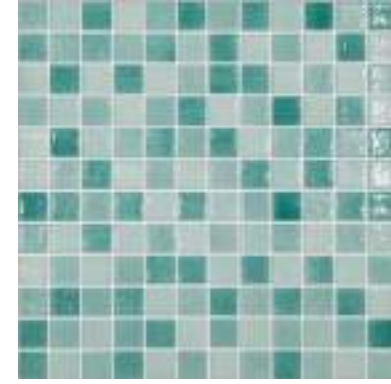

511 / 503 / 516

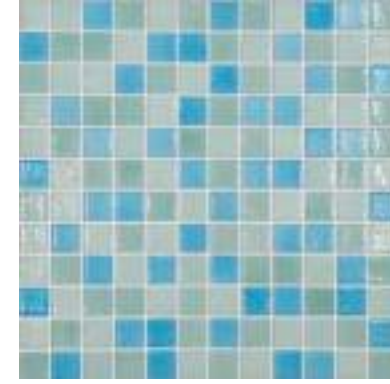

501 / 503 / 511

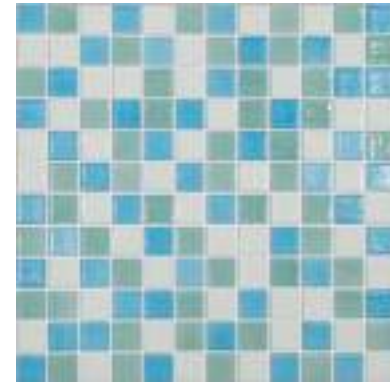

100 / 501 / 503

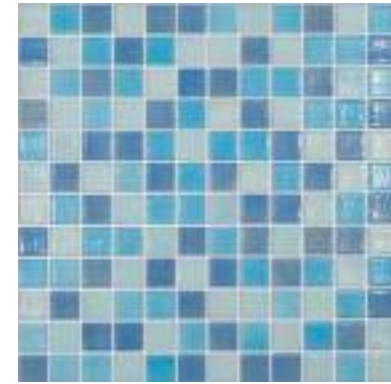

501 / 510 / 110

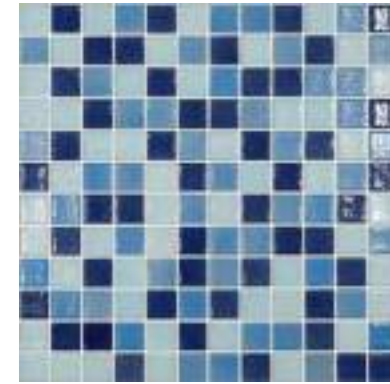

110 / 508 / 510

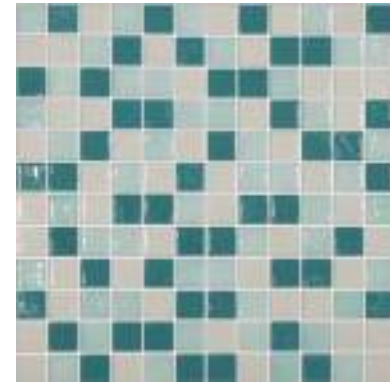

103 / 511 / 832

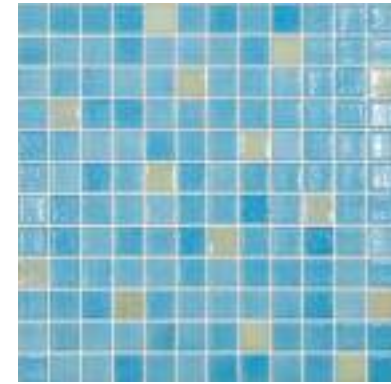

501 / 412 FG

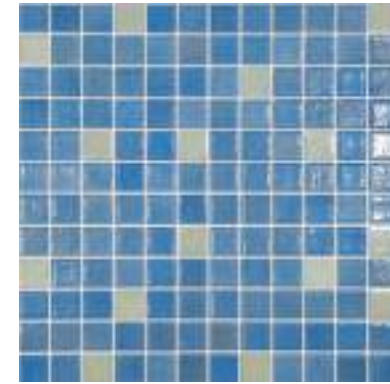

110 / 412 FG



THE SOMERSET ON GRACE BAY

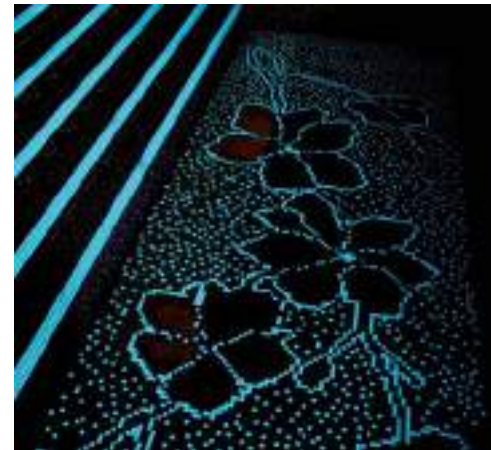
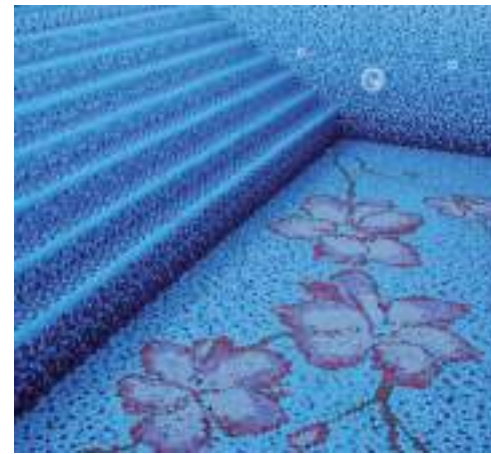

FIREGLASS

Se trata de un tipo de mosaico que posee la propiedad de emitir luz después de haber cesado la exposición a la fuente luminosa.

Brilla en la oscuridad creando efectos artísticos y visuales únicos. Bajo iluminación común, este mosaico presenta un aspecto totalmente normal.

* El efecto luminiscente es de duración limitada, se extingue con el tiempo. Se recomienda añadir lámparas uv para prolongar el efecto luminiscente

Fire glass

It is a mosaic that has the capacity to project light after the exposure of a light source.

It glows in the dark creating unique visual and artistic effects. Under common light, This mosaic shows a completely standard look.

* El efecto luminiscente es de duración limitada, se extingue con el tiempo. Se recomienda añadir lámparas uv para prolongar el efecto luminiscente

Luminescent

Il s'agit d'un type de mosaïque qui a la propriété d'émettre de la lumière après avoir cessé d'être exposé à la source lumineuse.

Elle brille dans l'obscurité et crée des effets artistiques et visuels uniques. Sous illumination commune, cette mosaïque présente un aspect complètement normal.

* El efecto luminiscente es de duración limitada, se extingue con el tiempo. Se recomienda añadir lámparas uv para prolongar el efecto luminiscente

226



PATIO BY CULZONI, SANTA FÉ

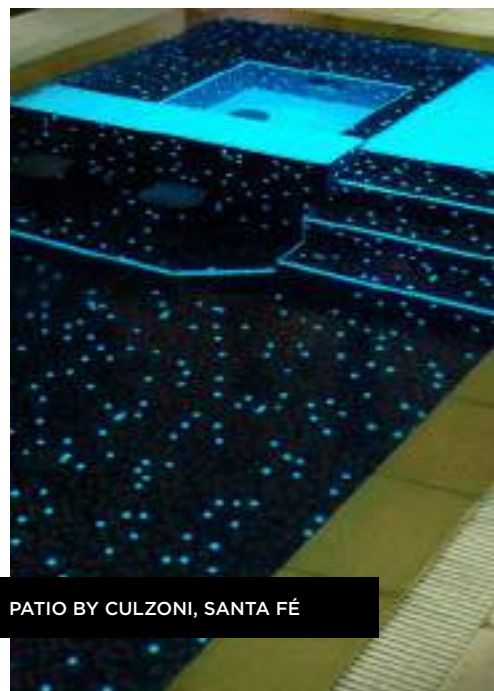

PATIO BY CULZONI, SANTA FÉ

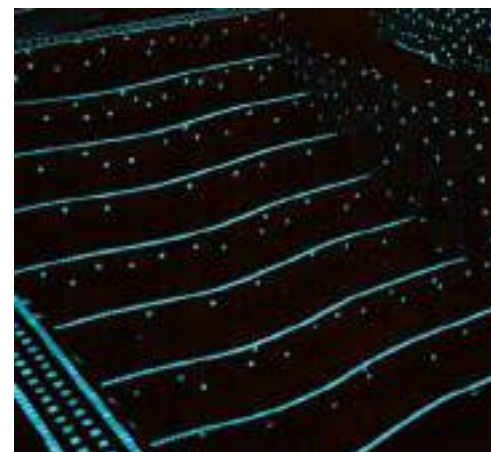
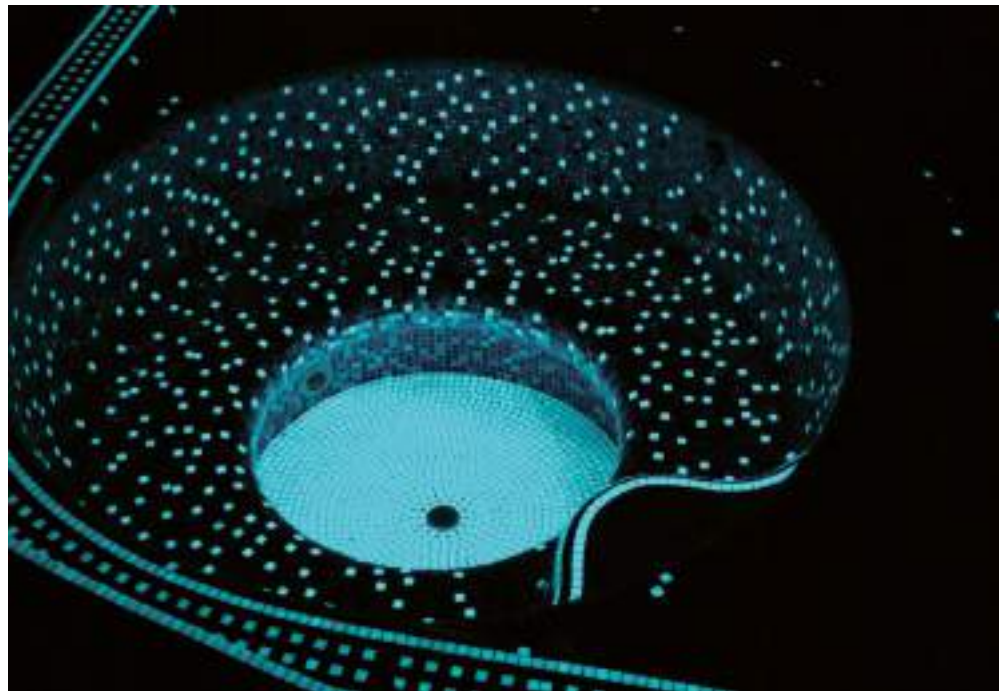

227



228



229

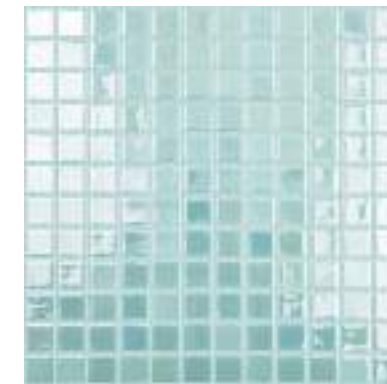

107 FIREGLASS



412 FIREGLASS



ATELIERLAB

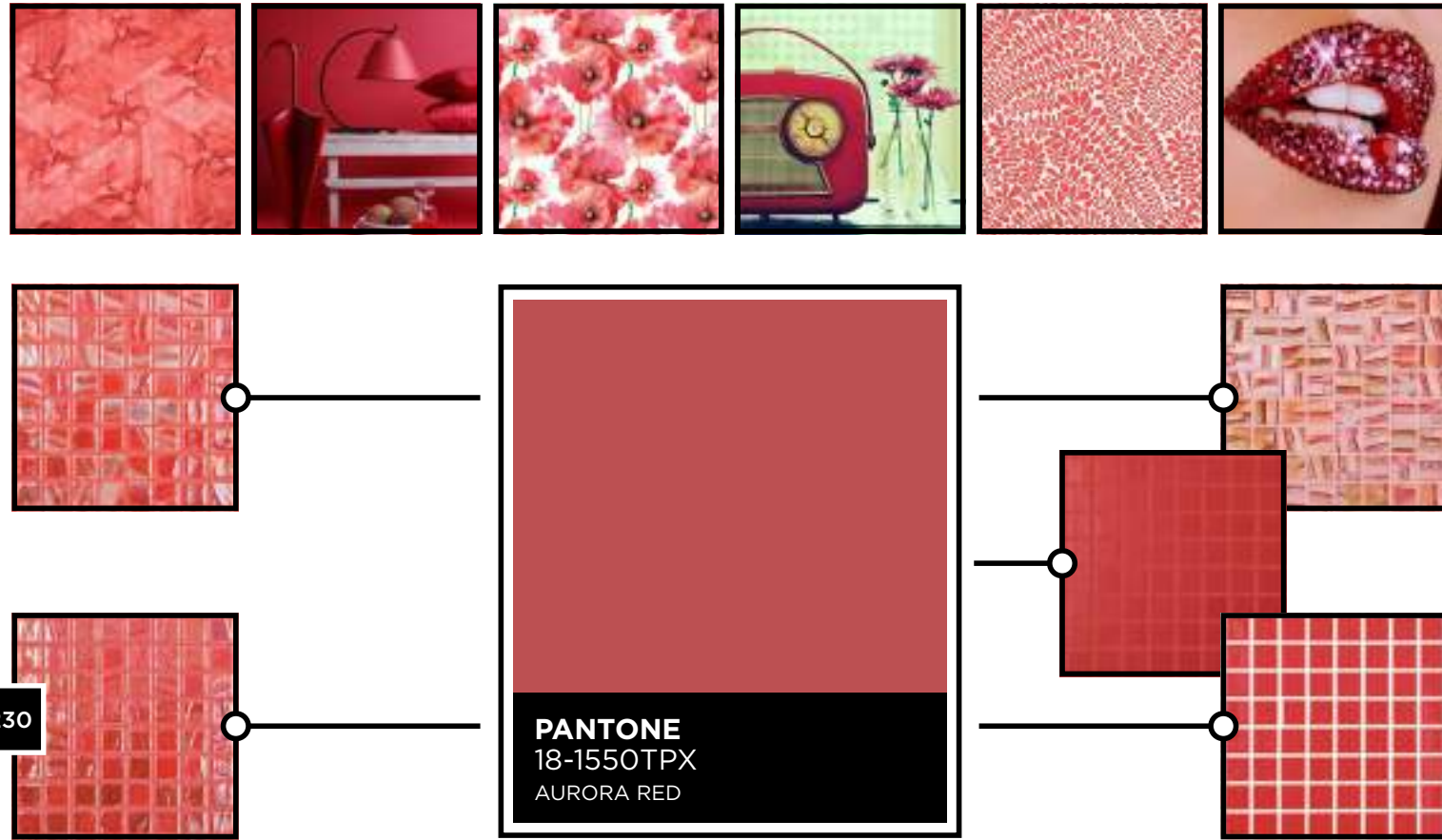

A medida. Vidrepur desarrolla el producto en función de la creatividad y las necesidades de decoradores, diseñadores e interioristas.

* Si no encuentra su color o textura en este catálogo, no dude en ponerse en contacto con nosotros. Le ayudaremos a desarrollar su pieza exclusiva acorde con su proyecto.

Made to measure. Vidrepur develops its products depending on the creativity and needs of decorators and interior designers.

Atelier lab es un departamento de desarrollo de producto de mosaico vítreo especializado en crear productos a medida para diseñadores, interioristas, decoradores y profesionales de la reforma.

Cuando se diseña un proyecto, el profesional requiere en muchas ocasiones de un producto distinto al que tenemos disponible en catálogo o producto standard.

Se requiere de colores especiales para combinar con otros materiales, de texturas distintas para realzar el mosaico vítreo y combinarlo con cerámica, papel pintado, mármol, madera, etc...

Nuestro departamento atelier, desarrolla estos productos especiales para que el profesional pueda ofrecer un producto armónico con el resto de materiales.



Atelier lab is a department that specializes in developing tailor made glass mosaic products for designers, interior designers and refurbishment professionals.

When a project is designed, professionals often require products that differ from standard products or from what is available in the catalogue.

Special colours are needed to combine with different materials, alternative textures are required to enhance the glass mosaic and combine it with ceramics, painted paper, marble, wood, etc.

Our atelier department develops these special products so professionals can offer a product that blends in with the rest of the materials.

El profesional de la decoración es una persona creativa, que busca la tendencia y la forma de ofrecer productos diferentes a sus clientes.

Interior designers are creative individuals in search of the latest trend and so offer different products to their clients.

Cuando el diseñador ya ha proyectado su estilo y su espacio, el siguiente paso es la búsqueda de materiales para poder realizar su proyecto.

Once designers have planned their style and space, they then go on to search for materials to carry out their project.

En muchas ocasiones, el mosaico vítreo adquiere mucho protagonismo en un proyecto decorativo, ya que es una pieza de gran valor, y por ese motivo podemos desarrollar el mosaico a medida para cada propuesta.

Glass mosaic very often stands out in interior design projects as it is highly valued, Which allows us to develop tailor made mosaics for each occasion.

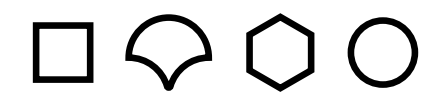
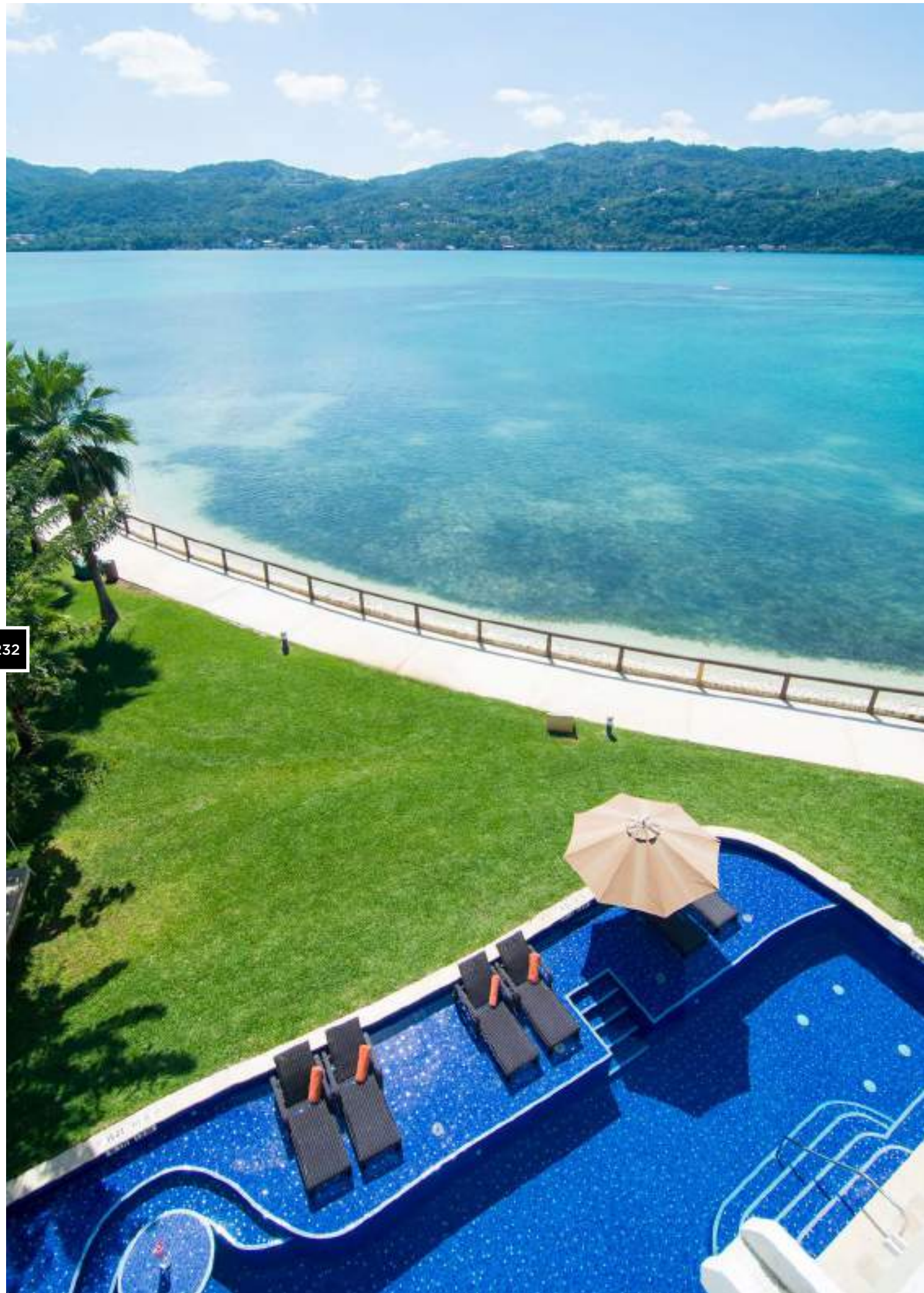

PROYECTOS

Vidrepur está especializado y posee la experiencia de muchos años en el mundo de la producción y realización de proyectos en mosaicos. Muchos prescriptores han contado con Vidrepur para obtener las mayores prestaciones y la calidad de un producto único y fabricado en España íntegramente.

Projects

Vidrepur specialises and has many years of experience in producing and developing mosaic projects. Numerous professionals have turned to Vidrepur in their quest for the high quality and top features of a unique product fully manufactured in Spain.



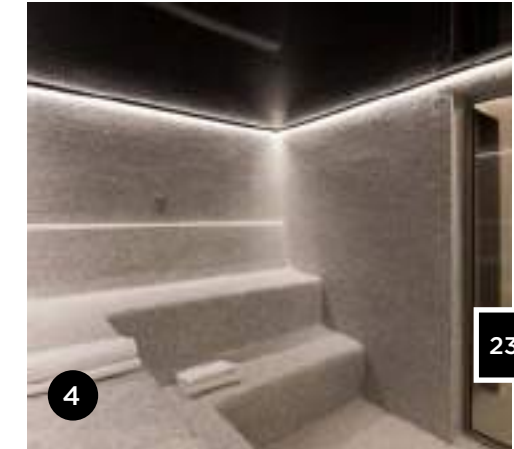

Projets





Vidrepur est spécialisé et a plusieurs années d'expérience dans le monde de la production et réalisation de projets en mosaïque. Plusieurs prescripteurs ont pu compter sur vidrepur pour obtenir les plus amples prestations et la qualité d'un produit unique et entièrement fabriqué en Espagne.



234

235

NUM	PROYECTO	REF.:
1	THE SOMERSET ON GRACE BAY TURKS & CAICOS ISLANDS	 710
2	HOTEL BOUTIQUE, ESPAÑA	 106
3	PISCINAS RESIDENCIALES / RESIDENTIAL POOLS	 750
4	PISCINAS RESIDENCIALES / RESIDENTIAL POOLS	 407

NUM	PROYECTO	REF.:
1	PISCINAS RESIDENCIALES / RESIDENTIAL POOLS	 CARRARA GREY MT
2	HOTEL CAPRICE ALCUDIA PORT	 503
3	HOTEL CALA DEL PI, GERONA	 516
4	HOTEL CAPRICE ALCUDIA PORT	 4102 TRAVERTINO BONE MT
5	SPA EN BÉLGICA	 EDNA WOOD DARK BLEND



AURA 25x25 MM						EDNA 25x25 MM				MAGIC 25x25 MM							
WHITE	SILVER	DARK BLUE	BLACK	COFFEE	SOFT RED	WHITE	BLACK	DARK BLUE	COFFEE	GOLD	SILVER	COPPER	BRONZE	BLACK			
MOON 25x25 MM						NATURE 25x25 MM 38x38 MM											
650	652	651	659	658	660												
ARTS 25x25 MM				SHELL 25x25 MM						SHELL H35							
950	951	952	1046	551	552	555	553	554	556	557	558	551H	553H	556H			
TITANIUM 25x25 mm										MAGIC 26X39 MM							
762	325	710	733	734	770	780	720	722	750	GOLD	SILVER	COPPER	BRONZE	BLACK			
LUX 25x25 mm																	
409	418	407	403	406	404	405	424										
LUX H35																	
409	403	6004	6001	6003	407												
COLORS 25x25 MM																	
100	109	108	900	828	102	107	106	800	803	832	916	897	600	602			
103	101	831	835	836	105	801	820	808	502	806	805	500	504	506			
3000	514	515	509	510	512	3007	501	110	508	511	503	516	877	507			
BIJOU 12x25 MM																	
WHITE	SATIN WHITE	SILVER	SOFT RED	COFFEE	BLACK												



WOODS 25x25 MM								NORDIC 25x25 MM							
MT 4202	MT 4201	MT 4200	MT 4204	MT 4202B	MT 4201B	MT 4200B	MT 4204B	909	908	903	910	925	926		
STONES 25x25 MM								MARBLES 25x25 MM							
MT 4102	MT 4101	MT 4100	MT 4102 B	MT 4101 B	MT 4100 B	MT 4302	BR 5300	MT 4300	MT 4302B	BR 5300B	MT 4300B	4221			
TERRE H35				LEGEND H35				MAGIC H35							
4700H	4700D	4701H	4701D	4217	4216	4218	4219	GOLD	SILVER	COPPER	BRONZE	BLACK			
TERRE H35				DESERT H35				MARBLES H35							
4702H	4709H	4705H	4703H	4706H	4222	4223	4224	4225	4708	4300	4220	4221			
NORDIC H35															
910H	908H	909H	903H	925H	926H	910/D	908/D	909/D	903/D	925/D	926/D				
SOUL 26X39 MM															
6102S	6103S	6101S	6104S	6100S	6105S	6106S	6107S	6109S	6108S	6000S BR	6005S BR	6001S BR	6003S BR	6004S BR	
DIMENSION 26X39 MM								DIAMOND H35							
6000/E	6007/E	6006/E	6004/E	6008/E	6005/E	4300/D	350/D	371/D	370/D	358/D	374/D	375/D			
CIRCLE 25x25 MM															
6106	6108	6000	6005	6001	6004	6002									
PEARL 12x12 MM															
450	451	452	453	454	455	456	457	458	459	460					

SOLUCIONES TÉCNICAS VIDREPUR

TECHNICAL SOLUTIONS / SOLUTIONS TECHNIQUES

1. CARACTERÍSTICAS TÉCNICAS
2. COLOCACIÓN 2,5X2,5
3. COLOCACIÓN H35
4. COMPENSADOR DE ESPESOR
5. TENAZAS DE CORTE
6. PLATO DE DUCHA COMPACTO
7. PELDAÑO
8. AREA TÉCNICA

1. TECHNICAL DATA
2. APPLICATION 2,5X2,5
3. APPLICATION H35
4. THICKNESS COMPENSATOR
5. NIPPERS
6. MOSAIC SHOWER TRAY
7. STEP
8. TECHNICAL AREA

1. DONNÉES TECHNIQUES
2. INSTALLATION 2,5X2,5
3. INSTALLATION H35
4. ÉGALISEUR
5. PINCE DE MOSAÏSTE DOUBLE MOLETTE
6. RECEVEUR DE DOUCHE COMPACT
7. STEP
8. SECTION TECHNIQUE



SOLUCIONES TÉCNICAS VIDREPUR CARACTERÍSTICAS TÉCNICAS | TECHNICAL DATA | DONNÉES TECHNIQUES

ABSORCIÓN DEL AGUA WATER ABSORPTION ABSORPTION DE L'EAU:	0%
RESISTENCIA AL HIELO FROST RESISTANT RÉSISTANCE À LA GELÉE:	NO HELADIZA - NOT DAMAGE NE GÈLE PAS
RESISTENCIA AL CHOQUE TÉRMICO THERMAL SHOCK RESISTANT RÉSISTANCE AU CHOC THERMIQUE:	SIN VARIACIÓN - RESISTANT SANS VARIATION
RESISTENCIA QUÍMICA CHEMICAL RESISTANT RÉSISTANCE CHIMIQUE:	ÁCIDOS Y ALCALINOS ACIDS & ALCALIS ACIDES ET ALCALINS
RESISTENCIA EN AUTOCLAVE PRESSURE COOKER AUTOCLAVE RESISTANT RÉSISTANCE EN AUTOCLAVE:	SIN VARIACIÓN UNCHANGING SANS VARIATION
RESISTENCIA A LA DILATACIÓN THERMAL EXPANSION RESISTANT RÉSISTANCE À LA DILATATION:	SIN VARIACIÓN NOT DAMAGE SANS VARIATION NOT DAMAGE
DURACIÓN LOST-LASTING DURÉE:	ILIMITADA UNLIMITED ILLIMITÉE
PESO ESPECÍFICO SPECIFIC WEIGHT POIDS SPÉCIFIQUE:	2,45 A 2,48 KG/DM ³
ÍNDICE DE REFRACCIÓN REFRACTIVE INDEX INDICE DE RÉFRACTION:	1,51 A 1,53
PUNTO DE REBLANDECIMIENTO THERMAL SHOCK RESISTANT POINT DE RAMOLLISSEMENT:	730°
COEFICIENTE DE DILATACIÓN LINEAL COEFFICIENT OF LINEAL EXPANSION COEFFICIENT DE DILATATION LINÉAIRE (ENTRE 0 Y 300°) (BETWEEN 0 & 300°) (ENTRE 0 ET 300°)	85 X 10 ⁻⁷
MÓDULO DE YOUNG YOUNG MODULUS MODULE DE YOUNG:	7 X 10 ⁹ KG/CM ²
DUREZA ESCALA MOHS MOHS HARDNESS SCALE DURETÉ ÉCHELLE DE MOHS:	4
ROCKWELL (C) ROCKWELL (C) ROCKWELL (C):	48 RC
CALOR ESPECÍFICO A 20°C SPECIFIC HEAT AT 20°C CHALEUR SPÉCIFIQUE A 20°C:	0,18 CAL/GR/°C
A 1000 °C AT 1000 °C:	0,32 CAL/GR/°C
CONDUCTIBILIDAD TÉRMICA A 20°C THERMIC CONDUCTIVITY AT 20 °C CONDUCTIVITÉ THERMIQUE À 20°C:	0,018 CAL/SEG/CM/°C
CONSTANTE DIALÉCTRICA (1MC A 20°C) DIALECTRIC CONSTANT (1MC AT 20°C) CONSTANTE DIÉLECTRIQUE (1MC À 20°C):	7,0 A 7,6
RESISTIVIDAD VOLUMEN A 250 °C VOLUME RESISTIVITY AT 250°C RÉSISTIVITÉ VOLUME À 250°C:	10 ^{6,5} X 10 ⁷ OHMS
FUERZA DIALÉCTRICA DIALECTRIC STRENGTH FORCE DIÉLECTRIQUE:	4500 KV/CM
DIFUSIVIDAD TÉRMICA THERMIC DIFUSSION DIFFUSIVITÉ THERMIQUE:	0,005 CM ² /SEG

ENSAYOS REALIZADOS EN LABORATORIOS HOMOLOGADOS / TESTS PERFORMED IN CERTIFIED LABORATORIES / ESSAIS RÉALISÉS DANS DES LABORATOIRES HOMOLOGUÉS

UNE-EN-ISO 10545-2	DETERMINACIÓN DEL ASPECTO SUPERFICIAL SURFACE RESISTANCE DÉTERMINATION DE L'ASPECT SUPERFICIEL
UNE-EN-ISO 10545-3	DETERMINACIÓN DE LA ABSORCIÓN DE AGUA WATER ABSORPTION DÉTERMINATION DE L'ABSORPTION DE L'EAU
UNE-EN-ISO 10545-11	DETERMINACIÓN DE LA RESISTENCIA AL CUARTEO BALDOSAS ESMALTADAS CRAZING RESISTANCE DÉTERMINATION DE LA RÉSISTANCE À LA FISSURATION DE CARREAUX ÉMAILLÉS
UNE-EN-ISO 10545-13	DETERMINACIÓN DE LA RESISTENCIA QUÍMICA CHEMICAL RESISTANCE DÉTERMINATION DE LA RÉSISTANCE CHIMIQUE
UNE-EN-ISO 10545-14	DETERMINACIÓN DE LA RESISTENCIA A LAS MANCHAS RESISTANCE TO STAINING DÉTERMINATION DE LA RÉSISTANCE AUX TACHES
UNE-ENV 12633 (CLASE II, CLASE III)	DETERMINACIÓN DE LA RESISTENCIA AL DESLIZAMIENTO/RESBALAMIENTO DE LOS PAVIMENTOS SIN PULIR ANTI-SLIP RESISTANCE DÉTERMINATION DE LA RÉSISTANCE AU GLISSEMENT DES SOLS NON
DIN- ANTISLIP 51097	DETERMINACIÓN DE LA RESISTENCIA AL DESLIZAMIENTO ANTI-SLIP RESISTANCE DÉTERMINATION DE LA RÉSISTANCE AU GLISSEMENT
UNE-EN-ISO 10545-7	DETERMINACIÓN DE LA RESISTENCIA A LA ABRASIÓN BALDOSAS ESMALTADAS ABRASION RESISTANCE DÉTERMINATION DE LA RÉSISTANCE À L'ABRASION DES CARREAUX ÉMAILLÉ

ICONOS | ICONS | ICONS

	REVESTIMIENTO WALL TILE CARRELAGE MURAL		MATE MATT MAT		SATINADO SATIN SATIN		BRILLO GLOSS BRILLANT
	PAVIMENTO FLOOR TILE CARRELAGE		MALLA MESH MAILLE		PAPEL PAPER PAPIER		PUNTOS DOTS POINTS
	ANTIDESLIZANTE ANTISLIP ANTIDÉRAPANT		METODO TORTUS TORTUS METHOD MAILLE		PIE DESCALZO BAREFOOT PIEDS NUS		PIE CALZADO FOOTWEAR CHAUSSURE PIED

RECOMENDACIONES A SEGUIR EN LA COLOCACIÓN USTED SABE, QUE UNA PERFECTA COLOCACIÓN ES LA MEJOR PUBLICIDAD QUE PUEDE OBTENER DE SU PROFESIONALIDAD. SI SIGUE LAS RECOMENDACIONES QUE LE EXPONEMOS, ESTAMOS SEGUROS QUE QUEDARÁ MUCHO MÁS SATISFECHO DE SU TRABAJO.

RECOMMENDATIONS HOW TO LAY THE MATERIAL

PERFECT MOSAIC APPLICATIONS IS THE BEST EXAMPLE TO OBTAIN. YOUR PROFESSIONAL SERVICES IF YOU FOLLOW OUR RECOMMENDATIONS, YOU WILL ACHIEVE PERFECT RESULTS.

RECOMMANDATIONS À SUIVRE POUR L'INSTALLATION

VOUS SAVEZ QU'UNE PARFAITE INSTALLATION EST LA MEILLEURE PUBLICITÉ POUR VOTRE PROFESSIONNALISME. SI VOUS SUIVEZ LES RECOMMANDATIONS QUE NOUS VOUS DONNONS, NOUS SOMMES SÛRS QUE VOUS SEREZ ENCORE PLUS SATISFAIT DE VOTRE TRAVAIL.



PAPEL | PAPER | PAPIER 315x315 mm (APROX)

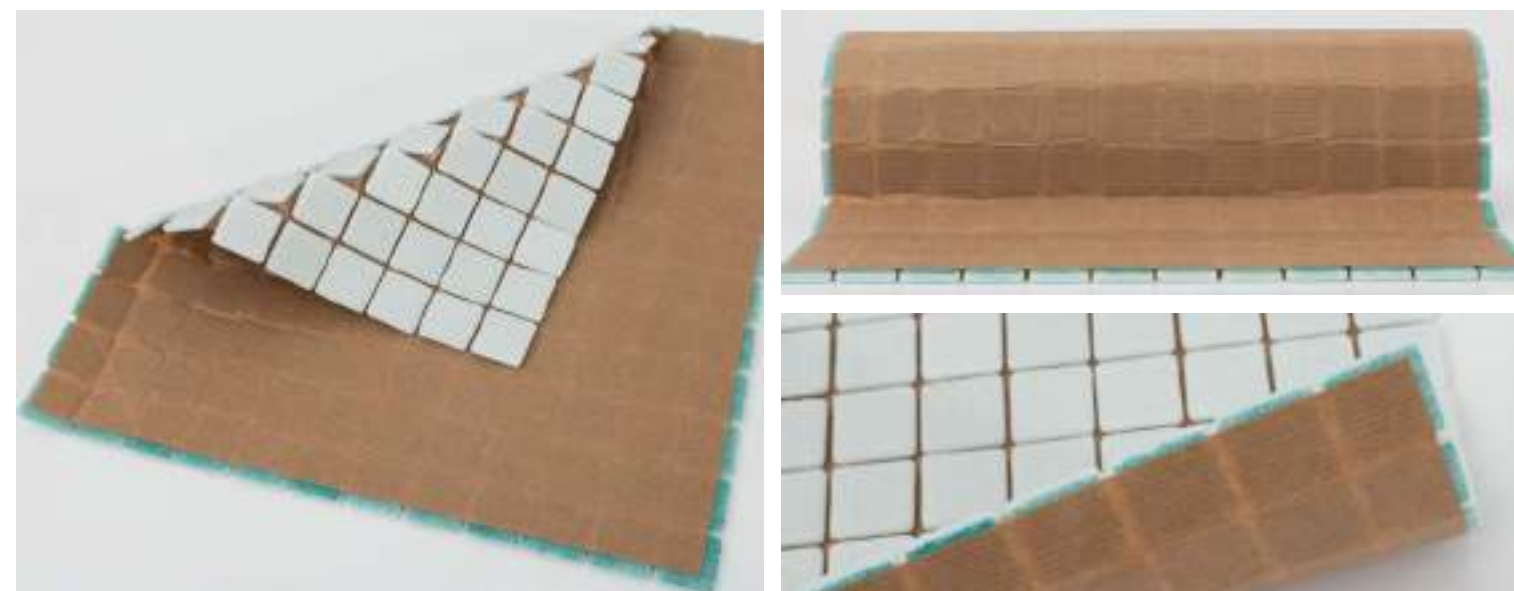

1. ES MUY CONVENIENTE QUE LA SUPERFICIE, PAREDES, SUELOS, SOBRE LOS QUE VAYA A SER APLICADO EL MATERIAL ESTÉN PERFECTAMENTE LISAS Y MESTREADAS, PARA OBTENER UN ACABADO PERFECTO.
2. AJUSTAR Y APLICAR LA PLACA SOBRE EL SOPORTE UNTADO CON COLA.
3. PRESIONAR CON LA AYUDA DE UNA LLANA DE MADERA O CAUCHO.
4. AL CABO DE 24 HORAS, MOJAR EL PAPEL KRAFT HASTA EMPAPARLO DE AGUA.
5. RETIRARLO CON LA AYUDA DE UNA ESPONJA PARA LIMPIAR LA COLA QUE QUEDE EN EL PAPEL.
6. PARA EFECTUAR LAS JUNTAS, EXTENDER UNA BARBOTINA DE PRODUCTO ESPECIAL PARA JUNTAS, CON UNA ESPÁTULA DE CAUCHO. PARA REJUNTAR EL MATERIAL, EXTENDER DIAGONALMENTE UNA BARBOTINA DE PRODUCTO ESPECIAL PARA JUNTAS CON UNA ESPÁTULA DE CAUCHO
7. LIMPIAR CON UNA ESPONJA HÚMEDA. ENJUAGAR Y SECAR CON UN TRAPO BIEN SECO.
8. SI HA SEGUIDO ESTAS INSTRUCCIONES, SU TRABAJO SERÁ MENOR Y SU RENDIMIENTO MEJORARÁ SENSIBLEMENTE.

1. AFIN D'OBTENIR UNE FINITION PARFAITE IL EST PRÉFÉRABLE QUE LA SUPERFICIE, LES MURS, LES SOLS, SUR LESQUELS SERA POSÉ LE MATÉRIEL SOIENT PARFAITEMENT LISSES ET PLANS.
2. AJUSTER ET POSER LA PLAQUE SUR LE SUPPORT ENDUIT DE COLLE.
3. FAIRE PRESSION À L'AIDE D'UNE TALOCHE EN BOIS OU CAOUTCHOUC.
4. AU BOUT DE 24 HEURES, MOUILLER LE PAPIER KRAFT JUSQU'À L'IMBIBER D'EAU.
5. LE RETIRER À L'AIDE D'UNE ÉPONGE AFIN DE RETIRER DU PAPIER TOUT EXCÈS DE COLLE.
6. POUR RÉALISER LES JOINTURES, ÉTENDRE UNE CAPE DE PRODUIT SPÉCIAL POUR JOINTURES À L'AIDE D'UNE SPATULE EN CAOUTCHOUC.
7. NETTOYER AVEC UNE ÉPONGE HUMIDE. RINCER ET SÉCHER AVEC UN CHIFFON BIEN SEC.
8. SI VOUS AVEZ SUIVI CES INSTRUCTIONS, VOTRE TRAVAIL SERA MOINDRE ET VOTRE RENDEMENT S'AMÉLIORERA SENSIBLEMENT.

* VIDREPUR RECOMMANDE L'USAGE DE JOINTS EPOXY.

1. THE SURFACE, WALLS, FLOORS - WHERE YOU ARE GOING TO PLACE THE MATERIAL, MUST BE PERFECTLY SMOOTH AND LEVELED, TO OBTAIN THE PERFECT FINISH.
2. ADJUST THE PLATE AND PLACE ON THE BASE SPREAD WITH GLUE.
3. PRESS WITH THE HELP OF A WOOD OR RUBBER TROWEL.
4. AFTER 24 HOURS SOAK THE KRAFT PAPER IN WATER UNTIL SATURATED.
5. REMOVE WITH THE HELP OF A SPONGE TO CLEAN OFF ANY GLUE LEFT ON THE PAPER.
6. TO FILL THE GAPS, APPLY A LAYER OF THE FILLING MATERIAL WITH THE HELP OF A SPATULA.
7. CLEAN WITH A DAMP SPONGE, RINSE AND DRY WITH A VERY DRY CLOTH.
8. IF YOU HAVE FOLLOWED THESE INSTRUCTIONS, YOU WILL ACHIEVE OPTIMAL RESULTS.



* SEGUIR EL LINK PARA EL VIDEO DE INSTALACIÓN - FOLLOW THE LINK FOR INSTALATION VIDEO.

MALLA | MESH | MAILLE 315x315 mm (APROX)

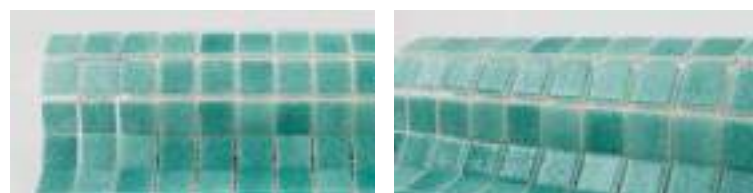
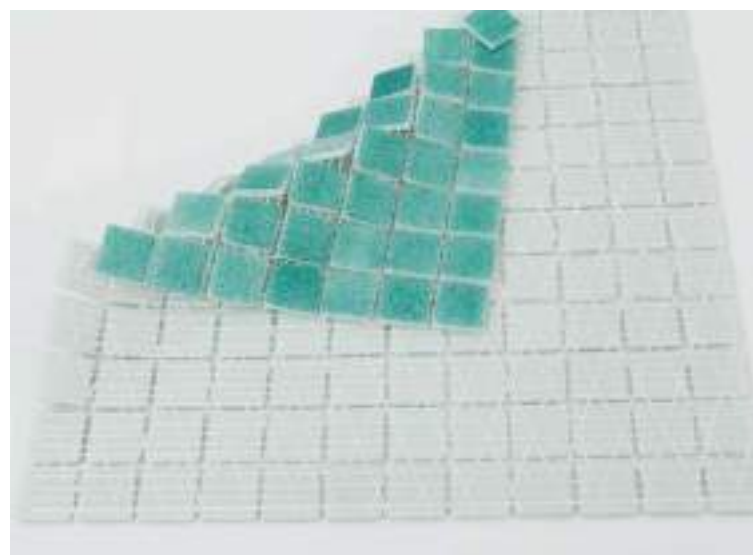

1. ES MUY CONVENIENTE QUE LA SUPERFICIE, PAREDES, SUELOS, SOBRE LOS QUE VAYA A SER APLICADO EL MATERIAL ESTÉN PERFECTAMENTE LISAS Y MESTREADAS, PARA OBTENER UN ACABADO PERFECTO.
2. AJUSTAR Y APLICAR LA PLACA SOBRE EL SOPORTE UNTADO CON COLA.
3. PRESIONAR CON LA AYUDA DE UNA LLANA DE MADERA O CAUCHO.
4. PARA EFECTUAR LAS JUNTAS, EXTENDER UNA BARBOTINA DE PRODUCTO ESPECIAL PARA JUNTAS, CON UNA ESPÁTULA DE CAUCHO.
5. LIMPIAR CON UNA ESPONJA HÚMEDA. ENJUAGAR Y SECAR CON UN TRAPO BIEN SECO.
6. SI HA SEGUIDO ESTAS INSTRUCCIONES, SU TRABAJO SERÁ MENOR Y SU RENDIMIENTO MEJORARÁ SENSIBLEMENTE.

1. THE SURFACE, WALLS, FLOORS ... WHERE YOU ARE GOING TO PLACE THE MATERIAL, MUST BE PERFECTLY SMOOTH AND LEVELED, TO OBTAIN THE PERFECT FINISH.
2. ADJUST THE PLATE AND PLACE ON THE BASE SPREAD WITH GLUE.
3. PRESS WITH THE HELP OF A WOOD OR RUBBER TROWEL.
4. TO JOIN, APPLY A LAYER OF THE ESPECIAL JOINING PRODUCT WITH A RUBBER SPATULA.
5. CLEAN WITH A DAMP SPONGE, RINSE AND DRY WITH A VERY DRY CLOTH.
6. IF YOU HAVE FOLLOWED THESE INSTRUCTIONS, YOU WILL ACHIEVE OPTIMAL RESULTS.

PUNTOS | DOTS | POINTS 315x396 mm

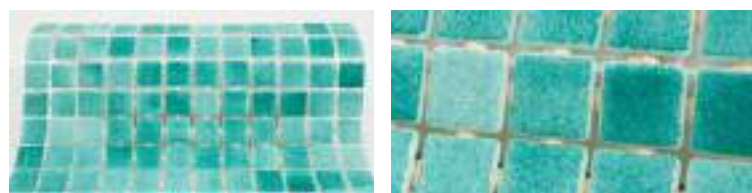

1. AFIN D'OBTENIR UNE FINITION PARFAITE IL EST PRÉFÉRABLE QUE LA SUPERFICIE, LES MURS, LES SOLS, SUR LESQUELS SERA POSÉ LE MATÉRIEL SOIENT PARFAITEMENT LISSES ET PLANS.
2. AJUSTER ET POSER LA PLAQUE SUR LE SUPPORT ENDUIT DE COLLE.
3. FAIRE PRESSION À L'AIDE D'UNE TALOCHE EN BOIS OU CAOUTCHOUC.
4. POUR RÉALISER LES JOINTURES, ÉTENDRE UNE CAPE DE PRODUIT SPÉCIAL POUR JOINTURES À L'AIDE D'UNE SPATULE EN CAOUTCHOUC.
5. NETTOYER AVEC UNE ÉPONGE HUMIDE. RINCER ET SÉCHER AVEC UN CHIFFON BIEN SEC.
6. SI VOUS AVEZ SUIVI CES INSTRUCTIONS, VOTRE TRAVAIL SERA MOINDRE ET VOTRE RENDEMENT S'AMÉLIORERA SENSIBLEMENT.

* VIDREPUR RECOMMANDE L'USAGE DE JOINTS EPOXY.



* SEGUIR EL LINK PARA EL VIDEO DE INSTALACIÓN - FOLLOW THE LINK FOR INSTALATION VIDEO.

VIDREPUR: MOSAICO HEXAGONAL MANOS EXPERTAS, DISEÑOS DE VANGUARDIA Y NUEVOS RELIEVES. CON ESTOS ELEMENTOS, LA FIRMA VIDREPUR FABRICA REVESTIMIENTO VÍTREO IDEAL PARA PISCINAS, FACHADAS Y DECORACIÓN DE INTERIORES, Y APORTA SOLUCIONES CON LAS QUE DECORAR ESPACIOS CON ESTILO.

VIDREPUR PRESENTA UN FORMATO ATRACTIVO Y VERSÁTIL: EL MOSAICO VÍTREO HEXAGONAL, EN DOS ACABADOS: SUPERFICIE LISA Y RELIEVE ASIMÉTRICO.

EN AMBOS CASOS, EL CORRECTO ALICATADO Y REJUNTADO ES PRIMORDIAL PARA DOTAR UN BUEN MATERIAL DE UN ELEGANTE ACABADO.

LA COLECCIÓN HONEY PRESENTA CARACTERÍSTICAS PROPIAS PARA UNA COLOCACIÓN EFICIENTE Y UN ACABADO CORRECTO.

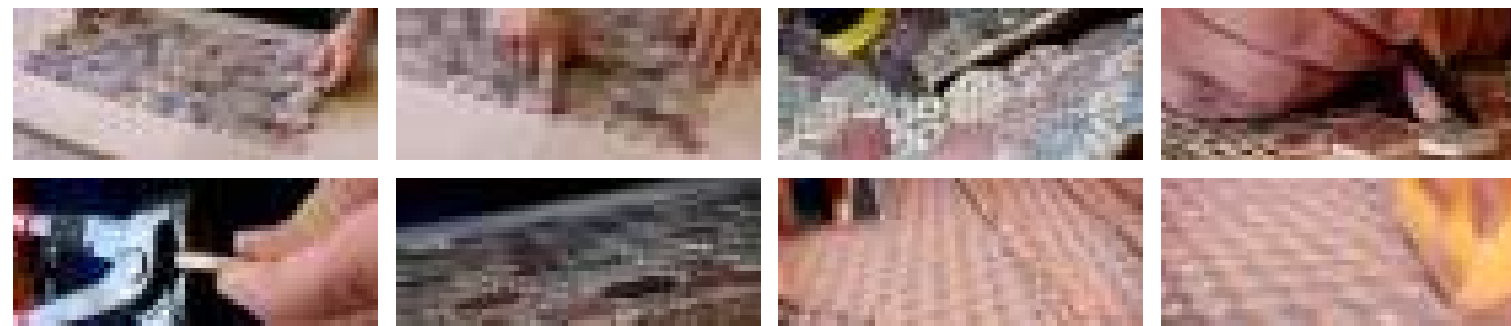

EL ENCAJADO DE LAS MALLAS

CADA LADO DE LA MALLA ENCAJA BIEN HEXAGONALMENTE, O BIEN EN FORMA DE SIERRA.

HEMOS DE COLOCAR LAS MALLAS EN SENTIDO LONGITUDINAL AL LADO MÁS LARGO DE LA PARED O SUPERFICIE A REVESTIR. ESTO FACILITARÁ LA FASE DE REJUNTADO DE LAS TESELAS AL QUEDAR TRAZADAS LÍNEAS RECTAS MÁS LARGAS LONGITUDINALES Y DEJANDO EN SENTIDO TRANSVERSAL EL TRAZADO CORTO.

EN CUANTO AL ACABADO DE LOS LATERALES, PODREMOS RECORTAR FÁCILMENTE LAS MALLAS CON UN CUTTER PARA AJUSTAR LAS MALLAS A LA SUPERFICIE.

COMPLETAR LAS MALLAS

EN ESTE PUNTO, NECESITAREMOS CORTAR CON ALICATES DE DIAMANTE ALGUNAS TESELAS PARA COMPLETAR LOS ESPACIOS HUECOS. EN EL CASO DE LAS TESELAS LISAS, MEDIREMOS LA LINEA A CORTAR Y USAREMOS LOS ALICATES PARA RECORTAR LA PIEZA. EN EL CASO DE LAS PIEZAS HEXAGONALES CON SUPERFICIE ASIMÉTRICA, DEBEREMOS ESCOGER EL LADO MÁS ESTRECHO, PARA EJERCER MEJOR LA PRESIÓN SOBRE LA TESELA Y PODER HACER UN CORTE MÁS PRECISO.

CON LAS PIEZAS RECORTADAS CUBRIREMOS LOS HUECOS Y DEJAREMOS LA SUPERFICIE LISTA PARA EL SIGUIENTE PASO.

EL REJUNTADO

ESTA FASE DE REJUNTADO ES MUY IMPORTANTE, YA QUE EL ACABADO DE LA JUNTA LA ESTÉTICA FINAL DEL AMBIENTE. TAMBIÉN JUEGA UN IMPORTANTE PAPEL EL COLOR DE LA JUNTA. HEMOS DE SELECCIONAR UN COLOR QUE COMBINE CON EL MOSAICO O CON EL ENTORNO. EN ESTE CASO, ADEMÁS SE UNEN LAS TESELAS CON RELIEVE ASIMÉTRICO A LA COLORACIÓN DEL MORTERO O MASILLA, CONSIGUIENDO UN SUGESTIVO EFECTO FINAL.

CON UNA LLANA DE GOMA, REPARTIMOS UNIFORMEMENTE LA PASTA SOBRE LAS PIEZAS. RETIRAMOS TODO EL SOBRENTE POSIBLE CON AYUDA DE LA LLANA DE GOMA Y LA ESPÁTULA.

USAREMOS LA ESQUINA REDONDEADA DE LA LLANA PARA RETIRAR EL MATERIAL SOBRENTE. EL CHAPADO DE LA SUPERFICIE EN SENTIDO LONGITUDINAL NOS FACILITARÁ EL TRABAJO.

PARA UNA SEGUNDA LIMPIEZA, USAREMOS UNA ESPONJA HÚMEDA EN EL MISMO SENTIDO PARA PROCURAR QUE AL RETIRAR LA PASTA SOBRENTE, LA JUNTA QUEDE UNIFORME ENTRE LAS PIEZAS.

TRAS ESTE PASO SE CORRIGEN POSIBLES GRUMOS, POROS O IMPERFECCIONES, DEJANDO LA SUPERFICIE LISTA PARA EL SIGUIENTE PROCESO.

EL TIEMPO DE SECADO DEPENDERÁ DE LAS INDICACIONES DEL FABRICANTE DEL MATERIAL, DE LAS CONDICIONES DE HUMEDAD, CALOR O TEMPERATURA.

A MEDIDA QUE SE SECA LA SUPERFICIE, LAS TESELAS ADQUIEREN UN TONO BLANQUECINO. CUANDO EL TONO SEA UNIFORME Y AL TACTO LA PASTA ESTÉ SECA, PROCEDEREMOS AL SIGUIENTE PASO.

EN CUANTO EL MATERIAL ESTÉ SECO, EMPLEAREMOS TELA O ESTROPAJO DE FIBRA SUAVE PARA RETIRAR TOTALMENTE LA PASTA, CONSIGUIENDO JUNTAS LIMPIAS, DEFINIDAS Y DEFINIDAS.

ASÍ, MEDIANTE UNA CORRECTA LIMPIEZA ASEGURAMOS QUE EL MATERIAL DE VIDREPUR MUESTRE LAS CARACTERÍSTICAS ORIGINALES DEL MATERIAL, COMO EL BRILLO Y EL ACABADO DE PIEZAS ESPECIALES.

VIDREPUR: HEXAGONAL MOSAICS. EXPERT PROFESSIONALS, CUTTING-EDGE DESIGNS AND NEW TEXTURES. VIDREPUR USES THESE ELEMENTS TO MANUFACTURE GLASS TILES THAT ARE IDEAL FOR SWIMMING POOLS, FAÇADES AND INTERIOR DECORATION, AND PROVIDES SOLUTIONS THAT ARE PERFECT FOR STYLISHLY DECORATED SPACES.

VIDREPUR OFFERS AN ATTRACTIVE AND VERSATILE FORMAT: HEXAGONAL GLASS MOSAICS WITH TWO DIFFERENT FINISHES: SMOOTH AND ASYMMETRIC.

IN BOTH CASES, THE RIGHT TILING AND GROUTING IS ESSENTIAL TO GIVE THE MATERIAL AN ELEGANT FINISH.

THE HONEY COLLECTION HAS EVERYTHING NEEDED FOR EFFICIENT PLACEMENT AND THE RIGHT FINISH.



FITTING THE MESH

EACH SIDE OF THE MESH FITS IN A HEXAGONAL SHAPE, OR IN A ZIGZAG ARRANGEMENT.

THE MESH HAS TO BE PLACED LONGWAYS ON THE LONGEST SECTION OF THE WALL OR SURFACE BEING COVERED. THIS MAKES THE GROUTING STAGE EASIER FOR THE TILES, AS THERE ARE LONGER STRAIGHT LINES, AND THE CROSSWISE PART IS THE SHORTER PART.

AS FOR THE FINISH ON THE SIDES, IT IS EASIER TO CUT THE MESH WITH A CUTTER, TO ADJUST THE NET TO THE SURFACE.

FINISHING THE MESH

AT THIS POINT, YOU WILL NEED TO CUT SOME OF THE TILES WITH DIAMOND PLIERS TO FILL IN ANY GAPS.

FOR SMOOTH TILES, MEASURE THE LINE TO CUT AND USE THE PLIERS TO TRIM THE TILE.

FOR HEXAGONAL TILES WITH AN ASYMMETRIC COATING, CHOOSE THE THINNEST SIDE SO THAT YOU CAN PLACE MORE PRESSURE ON THE TILES AND MAKE A MORE ACCURATE CUT.

USE THE TRIMMED TILES TO COVER THE HOLES AND LEAVE THE SURFACE SMOOTH FOR THE NEXT STEP.

GROUTING

THE GROUTING STAGE IS VERY IMPORTANT, AS THE FINISH OF THE GROUT MAKES A BIG DIFFERENT TO THE FINAL LOOK. THE COLOUR OF THE GROUT ALSO PLAYS AN IMPORTANT ROLE. CHOOSE A COLOUR THAT GOES WELL WITH THE MOSAIC, AND WITH THE SURROUNDINGS.

THE TILES WITH ASYMMETRIC COATING SHOULD ALSO MATCH THE COLOUR OF THE PUTTY, FOR AN OPTIMAL FINAL EFFECT.

USING A RUBBER TROWEL, SPREAD THE GROUT EVENLY OVER THE PIECES. REMOVE ANY EXCESS USING THE RUBBER TROWEL AND SPATULA.

USE THE ROUNDED EDGE OF THE TROWEL TO REMOVE ANY EXCESS MATERIAL. THE FINISH ON THE SURFACE IN A LONGWAYS DIRECTION SHOULD MAKE THIS EASIER.

TO CLEAN IT AGAIN, USE A DAMP SPONGE IN THE SAME DIRECTION TO TRY AND REMOVE THE EXCESS GROUT, SO THAT THE GROUT IS EVEN BETWEEN THE TWO PIECES.

AFTER THIS STEP, REMOVE ANY POSSIBLE LUMPS, PORES AND IMPERFECTIONS, LEAVING THE SURFACE READY FOR THE NEXT PROCESS.

THE DRYING TIME DEPENDS ON THE MANUFACTURER'S INSTRUCTIONS, AS WELL AS THE HUMIDITY, HEAT AND TEMPERATURE.

AS THE SURFACE DRIES, THE TILES WILL TAKE ON A WHITISH HUE. WHEN THE COLOUR IS UNIFORM AND THE GROUT IS DRY TO THE TOUCH, MOVE ON TO THE NEXT STEP.

AS SOON AS THE MATERIAL IS DRY, USE A CLOTH OR A SOFT SCOURER TO REMOVE THE GROUT, LEAVING IT CLEAN AND WELL-DEFINED.

BY CLEANING THEM PROPERLY, YOU WILL MAKE SURE THAT THE VIDREPUR MATERIAL MAINTAINS ITS ORIGINAL CHARACTERISTICS, SUCH AS THE SHINE AND FINISH OF CERTAIN TILES.

VIDREPUR: MOSAÏQUE HEXAGONALE. DES MAINS EXPERTES, DES DESIGNS AVANT-BOUREURS ET DES NOUVEAUX RELIEFS. LA MAISON VIDREPUR FABRIQUE, AVEC CES TROIS ÉLÉMENTS, DES REVÊTEMENTS EN PÂTE DE VERRE PARFAITS POUR LES PISCINES, FAÇADE ET DÉCORATION D'INTÉRIEUR. VIDREPUR OFFRE DES SOLUTIONS DE DÉCORATION POUR CRÉER DES ESPACES TENDANCE.

VIDREPUR VOUS PRÉSENTE UN FORMAT ATTRAYANT ET FLEXIBLE: LA MOSAÏQUE ÉMAILLÉE HEXAGONALE, AVEC DEUX FINITIONS: SURFACE LISSE ET RELIEF ASYMÉTRIQUE.

QUE VOUS CHOISSIEZ L'UNE OU L'AUTRE FINITION, UNE POSE ET UN JOINTOIEMENT MINUTIEUX SONT ESSENTIELS POUR OBTENIR DE TOUT BON MATÉRIEL UN RENDU ÉLÉGANT.

LA COLLECTION HONEY, GRÂCE À SES PROPRES SPÉCIFICITÉS, PERMET UNE POSE SIMPLE ET UNE EXCELLENTE FINITION.

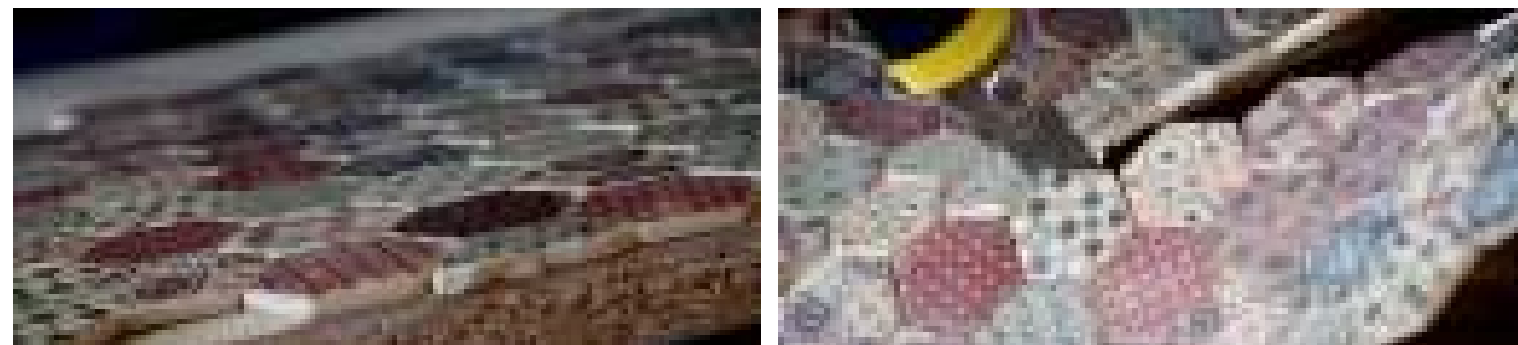

L'ASSEMBLAGE DES PLAQUES

CHAQUE CÔTÉ DE LA PLAQUE S'EMBOÏTE FACILEMENT EN HEXAGONAL OU EN FORME DE SCIE.

VOUS DEVEZ POSER LES TRAMES DANS LE SENS DE LEUR LONGUEUR EN PARTANT DU CÔTÉ LE PLUS LONG DU MUR OU DU SUPPORT À CARRELER. AINSI, IL SERA PLUS FACILE DE FAIRE LES JOINTS DES TESSELLES CAR LES LIGNES DROITES SERONT TRACÉES DANS LE SENS DE LA LONGUEUR TANDIS QUE DANS LE SENS TRANSVERSAL LE TRACÉ SERA PLUS COURT.

POUR LA FINITION DES LATÉRAUX, LES TRAMES PEUVENT ÊTRE FACILEMENT COUPÉES À L'AIDE D'UN CUTTER AFIN DE LES ADAPTER AU SUPPORT.

COMPLÉTER LES TRAMES

À CE STADE, NOUS DEVRONS COUPER CERTAINES TESSELLES AVEC DES PINCES À CÉRAMIQUE AFIN DE REMPLIR LES VIDES.

QUAND LES TESSELLES À DÉCOUPER SONT LISSES, IL SUFFIRA DE MESURER LA LIGNE À COUPER ET EMPLOYER LES PINCES POUR DÉCOUPER LA PIÈCE.

QUAND LES PIÈCES HEXAGONALES ONT UN RELIEF ASYMÉTRIQUE, IL EST IMPORTANT DE CHOISIR LE CÔTÉ LE PLUS ÉTROIT AFIN DE MIEUX APPUYER SUR LA TESSELLE ET FAIRE AINSI UNE COUPE PLUS PRÉCISE.

UNE FOIS LES PIÈCES DÉCOUPÉES, NOUS REMPLIRONS LES VIDES ET NOUS LAISSERONS LE SUPPORT PRÊT POUR L'ÉTAPE SUIVANTE.

LE JOINTOIEMENT

LE JOINTOIEMENT EST UNE ÉTAPE TRÈS IMPORTANTE CAR LE JOINT CONFÈRE AU MILIEU UN RENDU FINAL ESTHÉTIQUE. LA COULEUR DU JOINT JOUE ÉGALEMENT UN RÔLE FONDAMENTAL. IL FAUDRA CHOISIR UNE COULEUR EN HARMONIE AVEC LA MOSAÏQUE OU LE MILIEU.

DANS CE CAS, LES TESSELLES À RELIEF ASYMÉTRIQUE SE FONDENT DANS LA COLORATION DU MORTIER OU DE LA COLLE ET IMPRIMENT UN EFFET FINAL IMPRESSIONNANT.

NOUS DISTRIBUERONS UNIFORMÉMENT AVEC LA TALOCHE CAOUTCHOUC LA COLLE MASTIC SUR TOUTES LES PIÈCES.

NOUS ENLÈVERONS ENSUITE AU MAXIMUM L'EXCÈS À L'AIDE DE LA TALOCHE CAOUTCHOUC ET DE LA SPATULE.

NOUS UTILISERONS LE BORD ARRONDI DE LA TALOCHE POUR ENLEVER TOUT CE QUI EST DE TROP. LA POSE DU CARRELAGE DANS LE SENS DE LA LONGUEUR RENDRA LA TÂCHE PLUS FACILE.

ENSUITE NOUS UTILISERONS UNE ÉPONGE HUMIDE DANS LE MÊME SENS AFIN D'ENLEVER LES RESTES DE COLLE. LE JOINT DOIT ÊTRE UNIFORME ENTRE LES PIÈCES.

APRÈS CETTE ÉTAPE, IL FAUDRA ÉVENTUELLEMENT CORRIGER LES GRUMEAUX, LES PORES OU TOUT AUTRE DÉFAUT EN LAISSANT LA SURFACE CARRELÉE LISSE POUR L'ÉTAPE SUIVANTE.

LE TEMPS DE SÉCHAGE VARIE EN FONCTION DES RECOMMANDATIONS DU FABRICANT DE LA COLLE, DES CONDITIONS D'HUMIDITÉ, DE CHALEUR ET DE LA TEMPÉRATURE.

AU FUR ET À MESURE QUE LA SURFACE CARRELÉE SÈCHE, LES TESSELLES PRENNENT UNE TEINTE BLANCHÂTRE. LORSQUE L'ASPECT BLANCHÂTRE EST UNIFORME ET QUE LA COLLE EST SÈCHE AU TOUCHÉ, NOUS POUVONS PASSER À L'ÉTAPE SUIVANTE.

DÈS QUE LE MATÉRIEL EST SEC, NOUS EMPLOIERONS UN CHIFFON OU UN TAMPON À RÉCURER EN FIBRE POUR ENLEVER DÉFINITIVEMENT LE MASTIC. NOUS OBTIENDRONS ENFIN DES JOINTS PROPRES, DÉFINIS ET DÉLIMITÉS.

AINSI, APRÈS UN NETTOYAGE ADÉQUAT, NOUS AVONS TOUTES LES GARANTIES QUE LE MATÉRIEL DE VIDREPUR A FAIT RESSORTIR LES CARACTÉRISTIQUES INTRINSÈQUES DU MATÉRIEL TELLES QUE SA BRILLANCE ET LA FINITION DES PIÈCES SPÉCIALES.

* VIDREPUR RECOMMANDE L'USAGE DE JOINTS EPOXY.



* SEGUIR EL LINK PARA EL VIDEO DE INSTALACIÓN HONEY · FOLLOW THE LINK FOR HONEY INSTALLATION VIDEO.

PLACAS DE 30x30 CM ESPESOR 2,5 MM

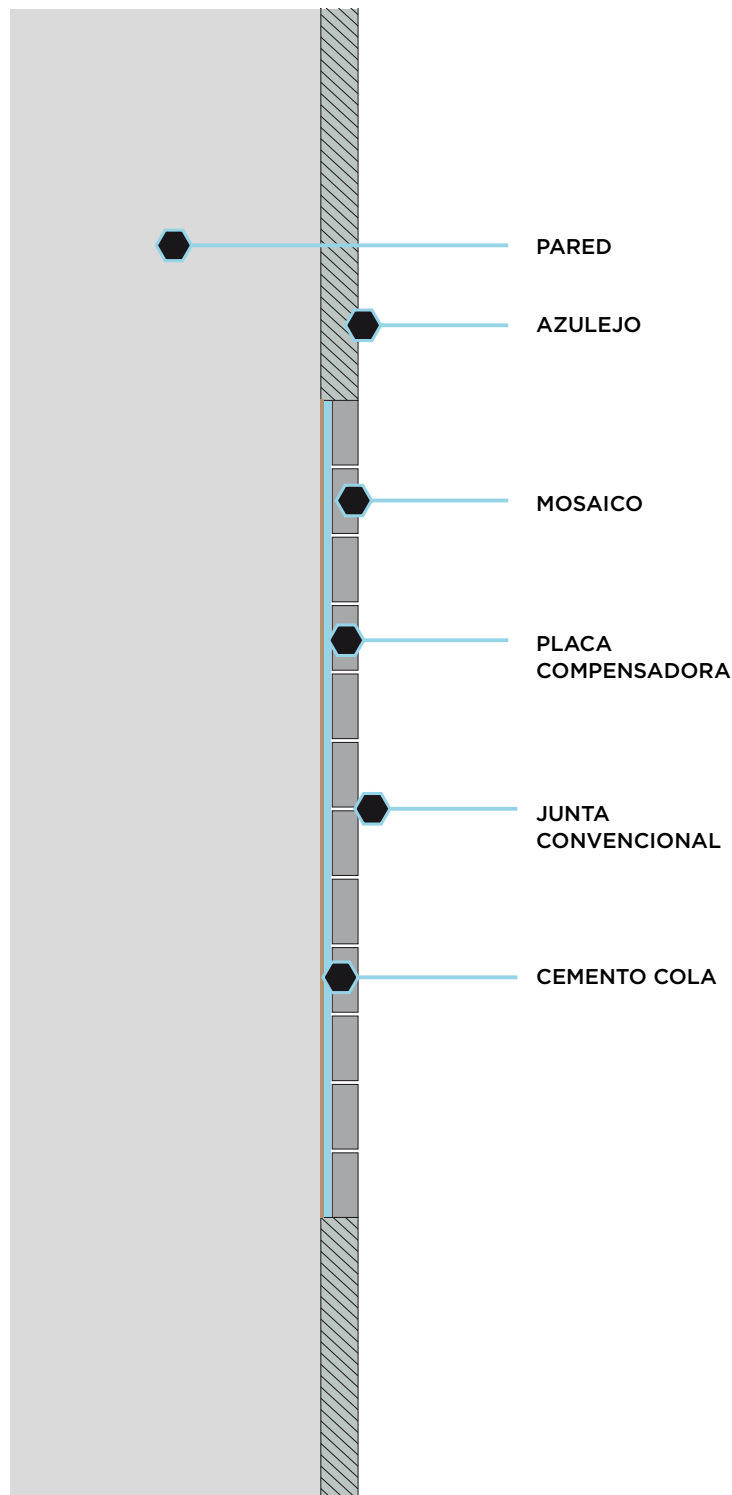
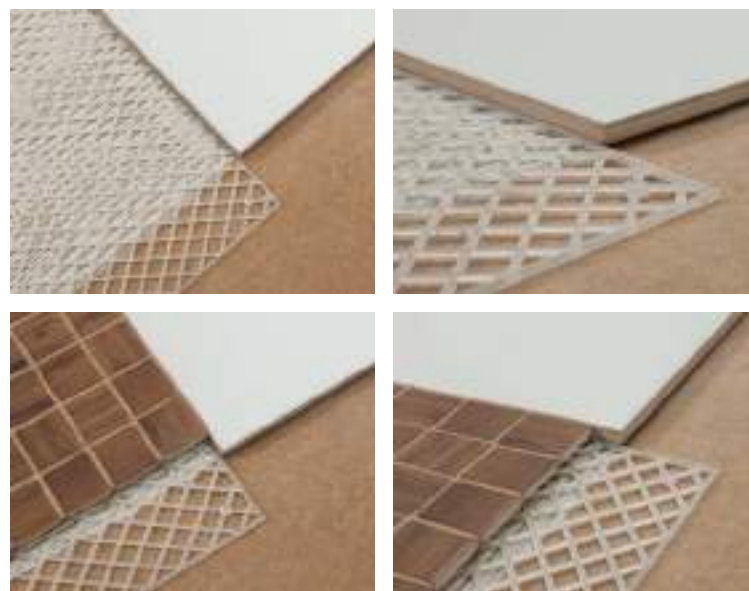
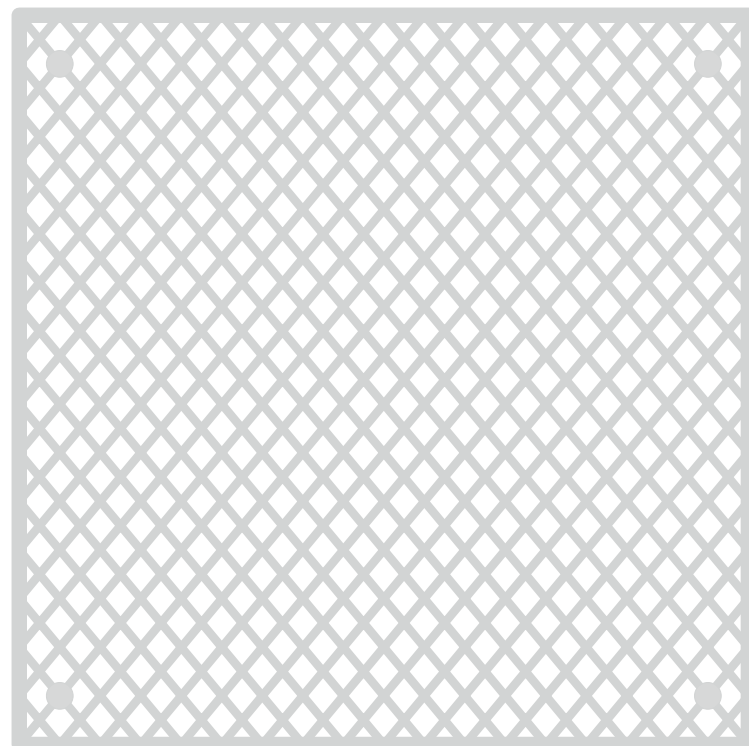

PLACAS DE 30x30 CM ESPESOR 2,5 MM

ESPECIALMENTE CONCEBIDO PARA LA APLICACIÓN DEL MOSAICO, Y SU COLOCACIÓN DETRÁS DEL MISMO.

- SE COLOCA ENTRE LA PARED Y EL MOSAICO PARA COMPENSAR LOS DIFERENTES ESPESORES DEL RESTO DE MATERIALES
- 5 HOJAS POR PAQUETE
- FORMATO 30x30 CM
- CORTE FÁCIL: SE ADAPTA A CUALQUIER FORMATO
- EL DISEÑO DE LA REJILLA DEL COMPENSADOR DE ESPESOR PERMITE QUE LA COLA PENETRE BIEN EN EL MOSAICO, Y ASEGURE ASÍ UN AGARRE PERFECTO.
- EL CORTE DE LA REJILLA ES MUY FÁCIL PARA PODER REALIZAR CUALQUIER ACABADO.
- LAS PRINCIPALES CARACTERÍSTICAS DE LA REJILLA SON, POR UN LADO SU FLEXIBILIDAD Y TAMBIÉN SU DISEÑO.
- PROCEDEREMOS A REVESTIR LA SUPERFICIE DE FORMA HABITUAL, COLOCANDO LAS MALLAS QUE PRECISEMOS.
- EN CASO NECESARIO, PODEMOS RECORTAR FÁCILMENTE LA REJILLA CON UN CÚTER Y RETIRAR LA MALLA SOBRENTE.

SHEETS MEASURING 30x30 CM. 2.5 MM THICK

SPECIALLY DESIGNED TO BE USED WHEN APPLYING MOSAIC TILES, PLACED BEHIND THE TILES.

- PLACED BETWEEN THE WALL AND THE MOSAIC TILES TO EVEN OUT THE DIFFERENT LEVELS OF THE MATERIALS
- 5 SHEETS PER PACKET
- SIZE 30X30 CM
- EASY TO CUT: CAN BE ADAPTED TO ANY FORMAT
- THE DESIGN OF THE GRID FOR THE TILE LEVELLER MEANS THAT THE GLUE CAN REACH THE MOSAIC TILES AND ENSURE THEY ARE WELL ATTACHED.
- IT IS VERY EASY TO CUT THE GRID FOR ANY TYPE OF FINISH.
- THE TILE GRID IS CHARACTERISED BY ITS FLEXIBILITY AND DESIGN.
- PREPARE THE SURFACE IN THE USUAL WAY, PLACING THE GRIDS WHERE REQUIRED.
- IF NECESSARY, CUT THE GRID WITH A BOX CUTTER AND REMOVE ANY EXCESS NETTING.

PLAQUES DE 30x30 CM. ÉPAISSEUR 2.5 MM

SPÉCIALEMENT CONÇU POUR LA POSE DES MOSAÏQUES ET POUR SA FIXATION AU DOS DES FILETS.

- IL DOIT ÊTRE POSÉ ENTRE LE SUPPORT ET LA MOSAÏQUE AFIN DE COMPENSER LES DIFFÉRENCES D'ÉPAISSEUR DES MATÉRIAUX UTILISÉS
- 5 FEUILLES PAR BLISTER
- FORMAT 30X30 CM
- DÉCOUPE AISÉE: IL S'ADAPTE À TOUS LES FORMATS
- LE QUADRILLAGE DU TREILLIS DE COMPENSATION A ÉTÉ CONÇU POUR PERMETTRE À LA COLLE DE PÉNÉTRER DANS LA MOSAÏQUE. IL ASSURE AINSI UN PARFAIT ACCROCHAGE
- LA DÉCOUPE DE LA PLAQUE EST TRÈS SIMPLE ET PERMET D'OBTENIR TOUS LES RENDUS.
- LES PRINCIPALES CARACTÉRISTIQUES DE L'ÉGALISEUR SONT SA FLEXIBILITÉ ET SA CONCEPTION.
- NOUS NOUS PRÉPARONS À REVÊTIR LE SUPPORT NORMALEMENT EN POSANT LES PLAQUES NÉCESSAIRES.
- NOUS POUVONS, LE CAS ÉCHÉANT, DÉCOUPER AISÉMENT L'ÉGALISEUR AU CUTTER ET ENLEVER CE QUI EST EN TROP.



TENAZAS DE CORTE

DURANTE LA COLOCACIÓN DEL REVESTIMIENTO VÍTREO VIDREPUR, PODEMOS NECESITAR, PARA COMPLETAR UNA SUPERFICIE, ALGUNAS PIEZAS DE TAMAÑO INFERIOR A LAS TESELAS DE NUESTRAS MALLAS.
ESTA SITUACIÓN PUEDE SOLVENTARSE CON LA SOLUCIÓN TÉCNICA QUE PROPONE VIDREPUR: LAS TENAZAS DE CORTE DE MOSAICO VÍTREO.

SE TRATA DE UNA HERRAMIENTA DE FÁCIL USO CON LA QUE CORTAREMOS SIN ESFUERZO CUALQUIERA DE LAS TESELAS VÍTREAS DEL CATÁLOGO DE VIDREPUR, PARA ADAPTARLAS A NUESTROS DISEÑOS.
SE RECOMIENDA USAR GAFAS DE SEGURIDAD PARA USARLAS SIN RIESGO. LAS TENAZAS DE CORTE SON EXTREMADAMENTE ÚTILES PARA DAR PEQUEÑOS TOQUES FINALES PARA ÁNGULOS Y FORMAS ESPECIALES, ROMPIENDO LAS TESELAS EN PEDAZOS PEQUEÑOS.

EL USO DE ESTAS TENAZAS ES SENCILLO Y NO REQUIERE DE GRAN ESFUERZO PUESTO QUE ESTÁN HECHAS DE ACERO FORJADO DE ALTA CALIDAD; LA HERRAMIENTA TIENE DOS AFILADAS RUEDAS DE CORTE DE CARBURO DE TUNGSTENO CON RECUBRIMIENTO DE NITRURO DE TITANIO, DE GRAN RESISTENCIA Y DURABILIDAD.

UNA PALANCA ALTAMENTE EFICAZ COMBINADA CON LOS PUNTOS CONCENTRADOS DE CONTACTO ENTRE EL MATERIAL Y LOS FILOS DE CORTE GARANTIZA UNAS FUERZAS DE CORTE EXTREMADAMENTE ALTAS Y RESULTADOS PRECISOS. EL ASA CUBIERTA DE PVC ASEGURA UN AGARRE SEGURO Y CÓMODO.

PODEMOS TRABAJAR DE FORMA FÁCIL CON LAS TENAZAS TANTO EN EL CASO DE PIEZAS SIMPLES, COMO EN PIEZAS DE NUESTRAS COLECCIONES DE MOSAICO HEXAGONAL, TANTO EN SUPERFICIE LISA COMO EN RELIEVE SIMÉTRICO O ASIMÉTRICO. INCLUSO EN PIEZAS SUPERIORES EL RESULTADO DEL TRABAJO CON LAS TENAZAS DE CORTE DE MOSAICO VÍTREO ES UN ACABADO PERFECTO.

NIPPERS

DURING THE PROCESS OF LAYING VIDREPUR GLASS MOSAICS, IN ORDER TO COVER THE COMPLETE SURFACE, WE MAY NEED SOME PIECES THAT ARE SMALLER IN SIZE THAN THE MOSAIC TILES (TESSERAE) OF OUR MESHES.

THIS SITUATION CAN BE SOLVED BY USING THE TECHNICAL SOLUTION OFFERED BY VIDREPUR: GLASS MOSAIC NIPPERS.

THIS TOOL, WHICH IS EASY TO USE, WILL EFFORTLESSLY CUT ANY OF THE TILES IN THE VIDREPUR CATALOGUE TO ADAPT THEM TO OUR DESIGNS.

SAFETY GLASSES ARE RECOMMENDED FOR THEIR RISK-FREE USE. NIPPERS ARE EXTREMELY USEFUL FOR BREAKING THE MOSAIC TILES INTO SMALL PIECES WHEN PUTTING THE FINAL TOUCHES TO ANGLES AND SPECIAL SHAPES.

OUR NIPPERS ARE EASY TO USE AND DO NOT REQUIRE MUCH EFFORT SINCE THEY ARE MADE OF HIGH QUALITY FORGED STEEL; THE TOOL HAS TWO SHARP CUTTING WHEELS MADE OF TUNGSTEN CARBIDE WITH A TITANIUM NITRIDE COATING OF GREAT RESISTANCE AND DURABILITY.

A HIGHLY EFFICIENT LEVER COMBINED WITH THE CONCENTRATED POINTS OF CONTACT BETWEEN THE MATERIAL AND THE CUTTING EDGES GUARANTEE AN EXTREMELY POWERFUL CUTTING STRENGTH AND PRECISE RESULTS. THE HANDLE WITH A PVC COATING ENSURES A SAFE AND COMFORTABLE GRIP.

IT IS EASY TO WORK WITH NIPPERS, WHETHER ON SINGLE PIECES OR ON PIECES FROM OUR SELECTION OF HEXAGONAL MOSAICS, BOTH ON SMOOTH SURFACES AND SURFACES WITH SYMMETRIC OR ASYMMETRIC RELIEF. EVEN WITH HIGH QUALITY PIECES, THE GLASS TILE NIPPERS WILL PROVIDE THE PERFECT FINISH.

PINCE DE MOSAÏSTE DOUBLE MOLETTE

LORS DE LA POSE DU REVÊTEMENT DE PÂTE EN VERRE VIDREPUR, IL SE PEUT QUE POUR TERMINER UN SUPPORT NOUS AYONS BESOIN DE QUELQUES PIÈCES PLUS PETITES QUE LES TESSELLES DE NOS FILETS.

NOUS POUVONS RÉSOUDRE CETTE PETITE DIFFICULTÉ EN UTILISANT LA SOLUTION TECHNIQUE QUE PROPOSE VIDREPUR: LA PINCE DE MOSAÏSTE DOUBLE MOLETTE.

SIMPLE À UTILISER, CET OUTIL SERT À COUPER SANS TROP D'EFFORT TOUTES LES TESSELLES DE PÂTE EN VERRE DU CATALOGUE DE VIDREPUR POUR QU'ELLES S'AJUSTENT À NOS CRÉATIONS.

IL EST RECOMMANDÉ DE PORTER DES LUNETTES DE SÉCURITÉ POUR UN EMPLOI EN TOUTE SURETÉ. LA PINCE À MOSAÏQUE EST EXTRÊMEMENT UTILE POUR FAIRE LES DERNIÈRES RETOUCHES DES ANGLES ET POUR CRÉER DES FORMES SPÉCIALES, EN COUPANT LES CARREAUX EN TOUT PETITS MORCEAUX.

L'UTILISATION DE CETTE PINCE, FABRIQUÉE EN ACIER FORGÉ DE HAUTE QUALITÉ, EST SIMPLE ET N'A BESOIN QUE PEU DE FORCE. ELLE DISPOSE DE DEUX MOLETTES DE COUPE EN CARBURE DE TUNGSTÈNE TRANCHANTES, AVEC REVÊTEMENT EN NITRURO DE TITANE À GRANDE RÉSISTANCE ET DURABILITÉ.

UN LEVIER HAUTEMENT EFFICACE EN COMBINAISON AVEC DES POINTS DE CONTACT CONCENTRÉS ENTRE LE MATÉRIEL ET LES RIVES DE COUPE GARANTIT DES FORCES DE COUPE EXTRÊMEMENT ÉLEVÉES ET DES RÉSULTATS PRÉCIS. LA POIGNÉE REVÊTUE DE PVC ASSURE UNE BONNE PRISE, À LA FOIS SURE ET COMMUNE.

NOUS POUVONS TRAVAILLER AISÉMENT AVEC LA PINCE DANS LE CAS DE PIÈCES SIMPLES MAIS AUSSI DE PIÈCES DE NOS COLLECTIONS DE MOSAÏQUE HEXAGONALE, AUSSI BIEN SUR DES CARREAUX LISSES QUE SUR CEUX À RELIEF SYMÉTRIQUE OU ASYMMÉTRIQUE. MÊME POUR DES PIÈCES SUPÉRIEURES, LE RÉSULTAT DU TRAVAIL AVEC LA PINCE À MOSAÏQUE EST UN RENDU PARFAIT.



PLATO DE DUCHA
 COMPACTO
 DE MOSAICO
 VITREO
 MOSAIC SHOWER TRAY

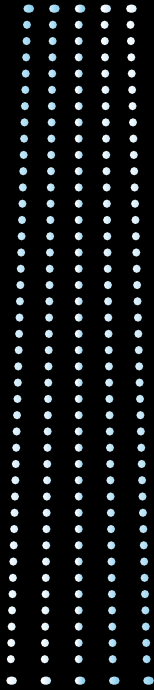

TECHNICAL SOLUTIONS BY VIDREPUR



PLATO DE DUCHA COMPACTO

VIDREPUR CONTINÚA OFRECIENDO DENTRO DE SU APARTADO DE SOLUCIONES TÉCNICAS, NUEVAS IDEAS CON EL FIN DE OFRECER UN ESTILO DE VIDA DE CALIDAD.

EL PLATO DE **DUCHA COMPACTO** CON MOSAICO VITREO. UNA GRAN REVOLUCIÓN EN EL MUNDO DE LA DECORACIÓN E INTERIORISMO.

UNO DE SUS ATRACTIVOS ES SU COMODIDAD EN EL TRANSPORTE Y COLOCACIÓN, POR SU REDUCIDO PESO (MUCHO MENOS QUE LOS DE CARGA MINERAL) Y AL MISMO TIEMPO **MUCHO MÁS RESISTENTES**.

SEGURIDAD DE IMPERMEABILIZACIÓN. PLATO **TOTALMENTE ESTANCO**.

VERSATILIDAD. EL VERDADERO ENCANTO DE ESTE PLATO DE DUCHA ES LA MAGIA DE SUS **NUMEROSOS ACABADOS** Y PERSONALIZACIONES QUE PODRÁS COMBINAR CON EL REVESIMIENTO Y COMPLEMENTOS DE TU BAÑO.

SIN DUDA TODO ESTO HACEN DEL PLATO DE DUCHA **VIDREPUR** UN AUTÉNTICO **ALIADO PARA TUS PROYECTOS**.

MOSAIC SHOWER TRAY

THROUGH ITS TECHNICAL SOLUTIONS SECTION, **VIDREPUR** CONTINUES TO OFFER NEW IDEAS FOR A QUALITY LIFESTYLE.

THE **COMPACT** GLASS MOSAIC **SHOWER TRAY**. A GREAT REVOLUTION IN THE WORLD OF DÉCOR AND INTERIOR DESIGN.

ONE OF ITS PLUS POINTS IS EASE OF TRANSPORT AND FITTING, OWING TO ITS REDUCED WEIGHT (MUCH LIGHTER THAN MINERAL TRAYS). IT IS ALSO **MUCH MORE RESISTANT**.

RELIABLE WATERPROOFING. TOTALLY WATERPROOF TRAY.

VERSATILITY. THE TRUE APPEAL OF THIS SHOWER TRAY IS THE MAGIC OF ITS **MANY FINISHES** AND CUSTOMISATIONS THAT YOU CAN COMBINE WITH THE FACINGS AND ACCESSORIES OF YOUR BATHROOM.

VIDREPUR SHOWER TRAYS ARE, WITHOUT A DOUBT, THE IDEAL **SOLUTION FOR YOUR DESIGN PLANS**.

RECEVEUR DE DOUCHE COMPACT

VIDREPUR CONTINUE DE PROPOSER DE NOUVELLES IDÉES PARMIS SA SECTION DE SOLUTIONS TECHNIQUES, AFIN D'OFFRIR UN STYLE DE VIE QUALITATIF.

LE RECEVEUR DE **DOUCHE COMPACT** EN MOSAÏQUES VITRÉES. UNE GRANDE RÉVOLUTION DANS LE MONDE DE LA DÉCORATION ET DU DESIGN INTÉRIEUR.

SON ATOUT MAJEUR : SON TRANSPORT ET SON INSTALLATION FACILES, SON POIDS RÉDUIT (BIEN INFÉRIEUR A CEUX EN CHARGE MINÉRALE) ET À LA **FOIS PLUS RÉSISTANT**.

SÉCURITÉ D'IMPERMÉABILISATION. RECEVEUR TOTALEMENT ÉTANCHE.

POLYVALENCE. LE VRAI CHARME DE CE RECEVEUR DE DOUCHE RÉSIDE DANS LA MAGIE DE SES NOMBREUSES FINITIONS ET PERSONNALISATIONS QUE VOUS POURREZ ASSORTIR AVEC LE REVÊTEMENT ET LES ACCESSOIRES DE VOTRE SALLE DE BAIN.

VOILÀ POURQUOI LE RECEVEUR DE DOUCHE VIDREPUR DEVIENT A COUP SÛR UN **ALLIÉ AUTHENTIQUE DE TOUS VOS PROJETS**.



4221 SUPREME MARQUINA
2,5X2,5 CM / 1"X1"

ELIGE EL ACABADO DE NUESTRO CATÁLOGO EN LOS FORMATOS 25X25 MM Y 38X38 MM

CHOOSE THE FINISH OF OUR CATALOG FROM OUR FORMATS IN 25X25 MM Y 38X38 MM

CHOISISSEZ LA FINITION DE NOTRE CATALOGUE DE NOS FORMATS EN 25X25 MM ET 38X38 MM

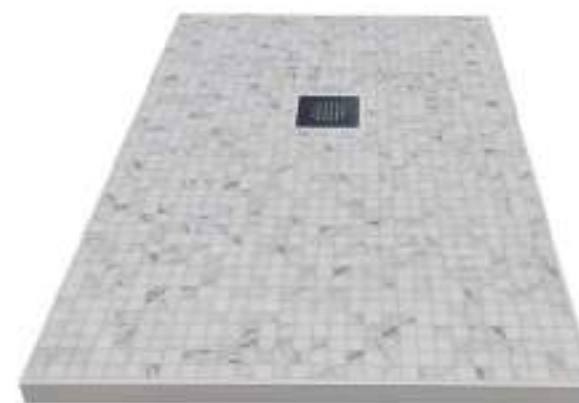

4302 CALACATTA MT
2,5X2,5 CM / 1"X1"

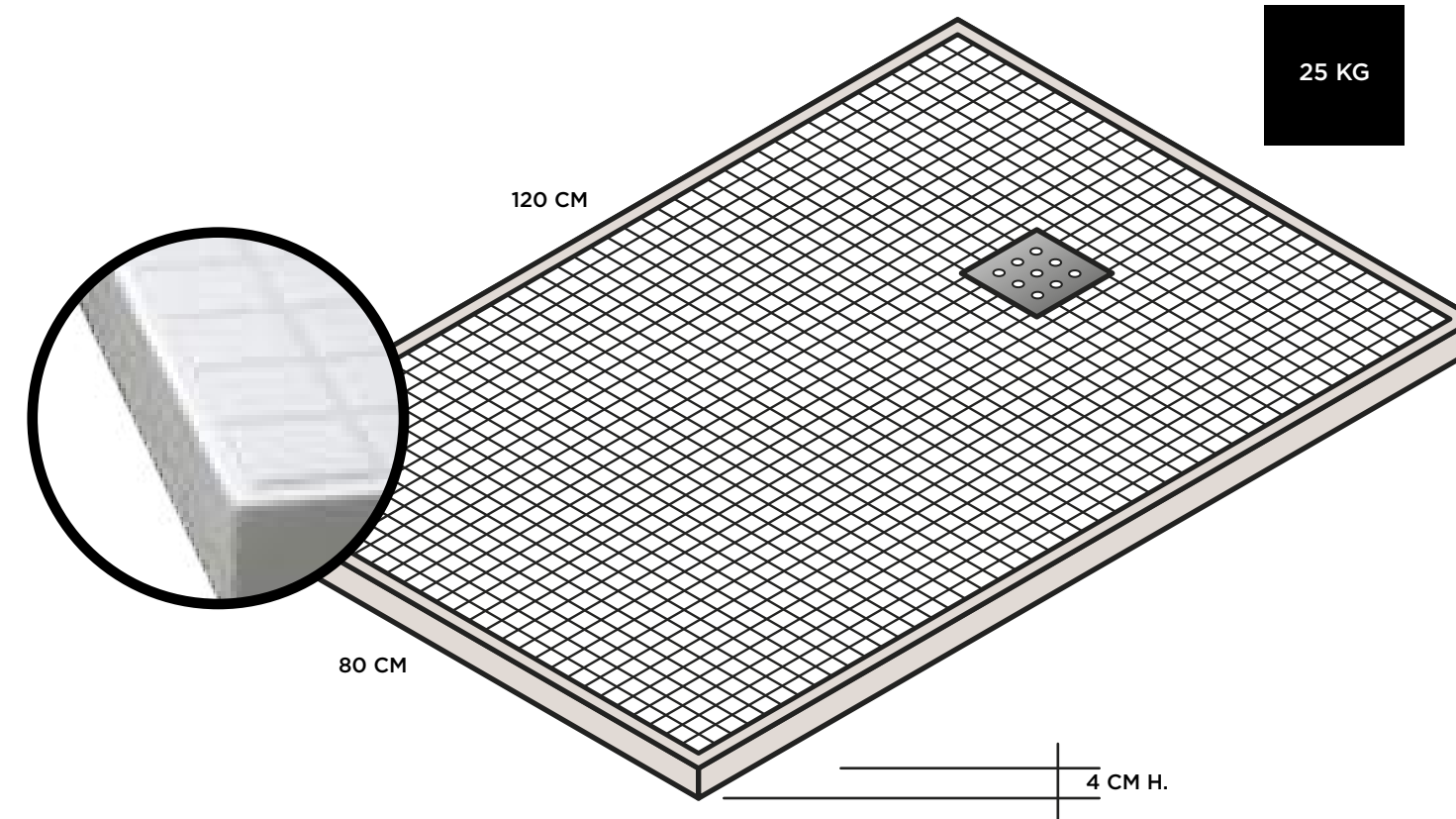

25 KG

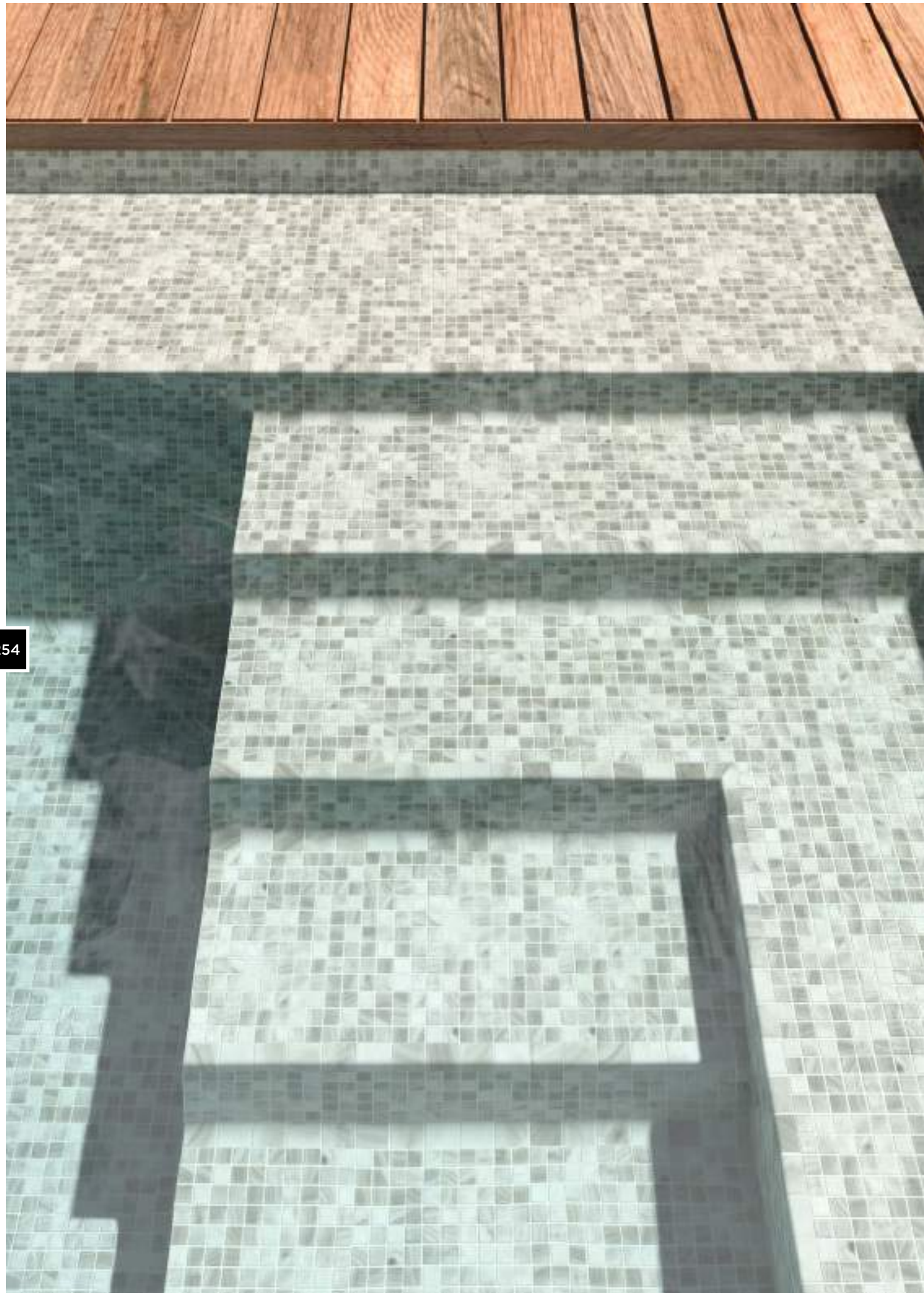

STEP

PIEZA PARA
REMATES
DE PELDAÑOS
DE PISCINAS

SPECIAL PIECES
FOR STEPS
IN SWIMMING
POOLS

SOLUCIONES TÉCNICAS VIDREPUR
PELDAÑO | STEP | STEP

SOLUCIONES TÉCNICAS VIDREPUR
STEPS

LAS PIEZAS ESPECIALES STEPS DE VIDREPUR ES NUESTRA ÚLTIMA NOVEDAD EN SOLUCIONES PARA PISCINAS SE TRATA DE UNA PIEZA DE 5CM Y 3,8CM DE ANCHO PARA REMATES, CUYAS CARACTERÍSTICAS TÉCNICAS, COLORES Y ACABADO ANTIDESLIZANTE SE CONVIERTEN EN UNA PIEZA CLAVE, VERSÁTIL Y MUY ÚTIL PARA TODO TIPO DE TERMINACIONES.

EXISTE UN AMPLIO ACABADO DE POSIBILIDADES EN COLORES Y ACABADOS, STEP CÓNCAVO Y STEP CONVEXO HEMOS INCLUIDO DENTRO DE ESTE ABANICO DE COLORES, LOS ACABADOS EN FIREGLASS, PARA REMARCAR ZONAS LUMINOSAS EN LA OSCURIDAD.

NUESTRO AFÁN EN OFRECER NUEVAS SOLUCIONES NO TERMINARÁ AQUÍ Y SEGUIREMOS APOSTANDO POR NUEVAS PIEZAS QUE PERMITAN SOLUCIONES MÁS COMODAS PARA EL COLOCADOR.

NUESTROS COLORES EN STEP:
REFERENCIA 403, 414, 406, 100, 107 FIREGLASS, 803, 412 FIREGLASS, EN ACABADO NORMAL Y ANTIDESLIZANTE Y COLECCIÓN NATURE

* EN CADA CAJA HAY 5 METROS LINEALES

TECHNICAL SOLUTIONS BY VIDREPUR
STEPS

THE SPECIAL TILES OF VIDREPUR'S STEPS COLLECTION ARE OUR LATEST INNOVATION IN POOL SOLUTIONS. THEY ARE 5CM-WIDE PIECES FOR TRIMS, WITH TECHNICAL CHARACTERISTICS, COLOURS AND ANTISLIP FINISH THAT MAKE THEM AN ESSENTIAL ITEM, VERSATILE AND EXTREMELY USEFUL FOR ALL TYPES OF FINISHES.

WE OFFER A WIDE RANGE OF COLOURS AND FINISHES FOR CONCAVE AND CONVEX STEP PROFILES. THIS COLOUR RANGE INCLUDES OUR GLOW-IN-THE-DARK FIREGLASS FINISHES FOR OUTDOOR APPLICATIONS.

WE CONSTANTLY ENDEAVOUR TO PROVIDE INNOVATIVE SOLUTIONS AND WE WILL CONTINUE TO CREATE NEW TILES THAT ARE CONVENIENT AND EASY TO LAY.

OUR STEP COLOURS:
REFERENCES: 403, 414, 406, 100, 107 FIREGLASS, 803, 412 FIREGLASS, IN NORMAL AND ANTISLIP FINISH AND NATURE COLLECTION.

* EACH BOX CONTAINS 5 LINEAR METRES

SOLUTIONS TECHNIQUES PAR VIDREPUR
STEPS

LES PIÈCES SPÉCIALISÉES STEPS DE VIDREPUR SONT NOS NOUVELLES SOLUTIONS LES PLUS RÉCENTES POUR LES PISCINES. IL S'AGIT D'UNE PIÈCE DE FINITIONS DE 5CM DE LARGE, DONT LES CARACTÉRISTIQUES TECHNIQUES, LES COULEURS ET LES ASPECTS ANTIDÉRAPANTS LA CONVERTISSENT EN UNE PIÈCE-CLEF, POLYVALENTE ET FORTEMENT UTILE POUR PARACHEVER TOUS GENRES DE TRAVAUX.

IL EXISTE TOUTE UNE GAMME DE POSSIBLES COULEURS ET DE FINITIONS, STEP CONCAVE ET STEP CONVEXE. NOUS AVONS INCLUS AU SEIN DE CET ÉVENTAIL DE COULEURS, LES FINITIONS FIREGLASS, POUR SOULIGNER DES ZONES LUMINEUSES DANS L'OBSCURITÉ.

NOTRE DÉSIR D'OFFRIR DE NOUVELLES SOLUTIONS N'EN RESTERA PAS LÀ, NOUS CONTINUERONS À MISER SUR DE NOUVELLES PIÈCES PERMETTANT DES SOLUTIONS PLUS AISÉES POUR L'INSTALLATEUR.

NOS COULEURS STEP :
RÉFÉRENCE 403, 414, 406, 100, 107 FIREGLASS, 803, 412 FIREGLASS, EN FINITION NORMALE, ANTIDÉRAPANTE ET NATURE SÉRIE

* CHAQUE CAISSE CONTIENT 5 MÈTRES LINÉAIRES

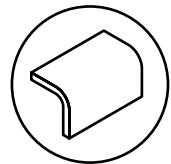

PIEZA CONVEXA PARA
LA ESQUINA DE LOS ESCALONES
Y CORONACIONES DE LAS PISCINAS

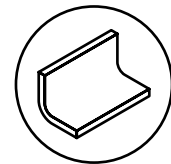

PIEZA CÓNCAVA DE TRANSICIÓN
ENTRE SUELO Y PARED

FORMATO - SIZE	FICHAS SHEET PLAQUE			CAJA BOX CAISSE		
	FICHAS / ML FICHAS / ML	FICHAS / M² FICHAS / SQM	M² / ML SQM / ML	KG / CAJA KG / BOX	ML / CAJA ML / BOX	KG / ML KG / ML
50x50 MM	20	360	0.0556	3.362	5	0.6724
38x38 MM	26	640	0.0406	1.75	3.85	0.4545

SOLUCIONES TÉCNICAS VIDREPUR
PELDAÑO | STEP | STEP

COLORS & LUX STEP

5 CM

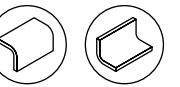

NATURE STEP (MATE Y BRILLO, GLOSS & MATT, BRILLANT ET MAT)

3,8 CM



5 CM

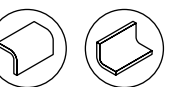

* DISPONIBLE EN ACABADO MATE Y PIEZA CÓNCAVA, EN FORMATO 3,8 CM Y 5 CM
* AVAILABLE IN MATT FINISH AND CONCAVE PIECE, IN 3,8 AND 5 CM FORMAT
* DISPONIBLE EN FINITION MATE ET EN PIECE CONCAVE, EN FORMAT 3,8 ET 5CM

SOLUCIONES TÉCNICAS VIDREPUR

ÁREA TÉCNICA | TECHNICAL AREA | SECTION TECHNIQUE

VIDREPUR CUENTA EN SU HABER CON LAS CERTIFICACIONES QUE ACREDITAN LA SUPERACIÓN DE LOS CONTROLES DE CALIDAD A QUE HAN SIDO SOMETIDOS SUS PRODUCTOS SEGÚN LAS NORMAS UNE, PARA GARANTIZAR UNAS ÓPTIMAS PRESTACIONES.

PROPIEDADES DEL MOSAICO VÍTREO

EL PRODUCTO SE PRESENTA EN PLACAS DE 315x315 MM (APROX), CON PIEZAS PEGADAS SOBRE PAPEL ENGOMADO, SOBRE FIBRA DE VIDRIO Y POLIÉSTER O CON PUNTOS. POR SU INALTERABILIDAD, FÁCIL LIMPIEZA Y COLOCACIÓN, SON EL REVESTIMIENTO DECORATIVO IDEAL PARA REVESTIR PISCINAS, FACHADAS, COLUMNAS, INTERIORES, CUARTOS DE BAÑO, ETC. CON LA UTILIZACIÓN DEL VIDRIO Y EL COLOR SE CONSIGUEN SOLUCIONES MÁS DECORATIVAS Y SUGESTIVAS.

VIDREPUR HOLDS CERTIFICATES FOR THE HIGH QUALITY OF ITS PRODUCTS WICH HAVE BEEN SUBMITTED TO STRICT QUALITY CONTROLS ACCORDING TO UNE STANDARDS.

PROPERTIES OF GLASS MOSAIC

THIS PRODUCT IS PRESENTED IN SHEETS OF 315x315 MM (APPROX), WITH PIECES GLUED TO ADHESIVE PAPER, GLASS FIBER AND POLYESTER MESH OR DOTS. UNALTERABLE, EASY TO CLEAN AND APPLY, IT IS THE IDEAL DECORATIVE COVERING FOR SWIMMING POOLS, EXTERIORS, PILLARS, INTERIORS, BATHROOMS, ETC. THE USE OF GLASS AND COLOUR MAKES FOR VERTY DECORATIVE AND ATTRACTIVE SOLUTIONS.

VIDREPUR A OBTENU LES CERTIFICATIONS QUI CONFIRMENT QUE SES PRODUITS ONT PASSÉ LES CONTRÔLES SELON LES NORMES « UNE » (RÈGLEMENTATION ESPAGNOLE) ET QUI GARANTISSENT LES PRESTATIONS OPTIMALES.

PROPRIÉTÉ DE LA MOSAÏQUE DE VERRE

LE PRODUIT EST PRÉSENTÉ EN PLAQUES DE 315X315 MM (APPRO), AVEC DES PIÈCES COLLÉES SUR PAPIER GOMME, SUR FIBRE DE VERRE ET POLYESTER OU AVEC DES POINTS. SON INALTÉRABILITÉ, LA FACILITÉ DE NETTOYAGE ET D'INSTALLATION EN FONT UN REVÊTEMENT DÉCORATIF IDÉAL POUR COUVRIR PISCINES, FAÇADES, COLONNES, INTÉRIEURS, SALLES DE BAINS, ETC. L'UTILISATION DU VERRE ET DES COULEURS PERMET DES SOLUTIONS PLUS DÉCORATIVES ET SUGGESTIVES.



VIDEPUR Y EL CERTIFICADO LEED

EL CERTIFICADO LEED TIENE COMO OBJETIVO LA SENSIBILIZACIÓN DEL MUNDO DE LA CONSTRUCCIÓN Y DE LA ARQUITECTURA PARA DESARROLLAR PROYECTOS DE FORMA ECOSOSTENIBLE, MEDIANTE UN SISTEMA DE CERTIFICACIÓN POR PUNTOS APLICADO A LOS EDIFICIOS CONSTRUIDOS.

LA ASIGNACIÓN DE LOS PUNTOS SE BASA EN EL CÁLCULO DE CRÉDITOS ASIGNADOS PARA CADA UNO DE LOS REQUISITOS QUE CARACTERIZAN LA SOSTENIBILIDAD DEL EDIFICIO. DE LA SUMA DE LOS CRÉDITOS DERIVA EL GRADO DE CERTIFICACIÓN. NUESTROS PRODUCTOS CONTRIBUYEN EN LA PUNTUACIÓN DENTRO DEL APARTADO MR4.

LOS PARÁMETROS PARA LA ASIGNACIÓN DE LOS CRÉDITOS SON DEFINIDOS POR UN PANEL DE EXPERTOS, QUE VALORA LA TOTALIDAD DEL PROYECTO, TANTO EL DISEÑO DEL PROYECTO, COMO LOS MATERIALES UTILIZADOS EN UNA VALORACIÓN ECOLÓGICA DE LOS EDIFICIOS, INCLUYENDO EL RENDIMIENTO ECOLÓGICO DE UN EDIFICIO.

VIDREPUR AND LEED CERTIFICATION

THE GOAL OF LEED STANDARDS IS PROMOTING AWARENESS OF ENVIRONMENTALLY SUSTAINABLE CONSTRUCTION AMONG BUILDERS AND ARCHITECTS WITH A FLEXIBLE BUT WELL-ARTICULATED POINT SYSTEM FOR BUILDING CERTIFICATION.

POINTS ARE ASSIGNED ON THE BASIS OF CALCULATION OF CREDITS ASSIGNED FOR EACH OF THE REQUIREMENTS DETERMINING THE BUILDING'S SUSTAINABILITY. THE TOTAL NUMBER OF CREDITS DETERMINES THE CERTIFICATION LEVEL. THE TOTAL NUMBER OF CREDITS DETERMINES THE CERTIFICATION LEVEL AND VIDREPUR PRODUCTS IN THE SECTION MR4 CAN CONTRIBUTE TO SCORE OF 1 TO 2 POINTS.

THE PARAMETERS FOR CREDITS ASSIGNMENT ARE NOW DEFINED ACCORDING TO LEED, IT SETS THE STANDARD FOR BEST PRACTICE IN SUSTAINABLE DESIGN AND HAS BECOME THE DE FACTO MEASURE USED TO DESCRIBE A BUILDING'S ENVIRONMENTAL PERFORMANCE.

VIDEPUR ET LE CERTIFICAT LEED

LE CERTIFICAT LEED A POUR OBJECTIF LA SENSIBILISATION DU MONDE DE LA CONSTRUCTION ET DE L'ARCHITECTURE DANS LE DÉVELOPPEMENT DE PROJETS ECODURABLE, MOYENNANT UN SYSTÈME DE CERTIFICATION PAR POINTS APPLIQUÉ AUX IMMEUBLES CONSTRUIITS.

L'ATTRIBUTION DES POINTS SE BASE SUR LE CALCUL DE CRÉDITS ATTRIBUÉS POUR CHACUN DES REQUISITS QUI CARACTÉRISENT LA DURABILITÉ DE L'IMMEUBLE. DE LA SOMME DES CRÉDITS DÉRIVE LE GRADE DE CERTIFICATION. NOS PRODUITS DE LA SECTION MR4 PEUVENT CONTRIBUER À UNE PONCTUATION DE 1 À 2 POINTS.

LES PARAMÈTRES POUR L'ATTRIBUTION DES CRÉDITS SONT DÉFINIS PAR UN PANEL D'EXPERTS QUI ÉVALUENT LA TOTALITÉ DU PROJET, LE DESIGN DU PROJET ET LES MATÉRIAUX UTILISÉS DANS UNE ÉVALUATION ÉCOLOGIQUE DES IMMEUBLES, TOUT EN PRENANT EN COMPTE LE RENDEMENT ÉCOLOGIQUE D'UN IMMEUBLE.

POR FAVOR, CONSULTE NUESTRAS CONDICIONES DE VENTA EN WWW.VIDREPUR.COM
PLEASE, YOU CAN CONSULT TERMS AND CONDITIONS IN OUR WEBSITE WWW.VIDREPUR.COM

FOLLOW US



VIDREPUR

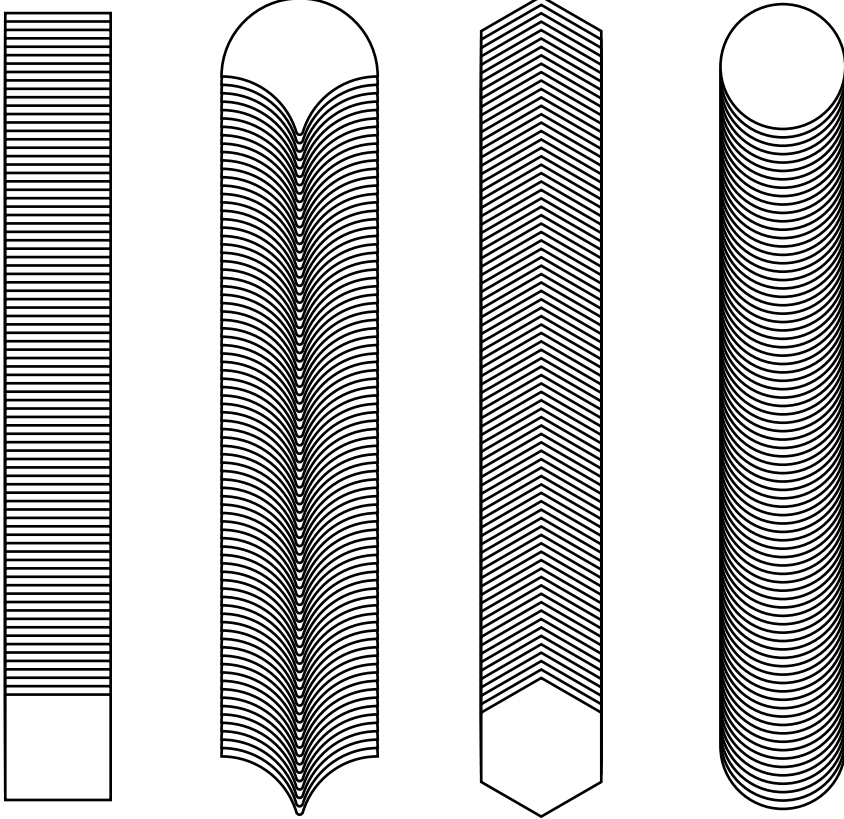

VIDREPUR

GLASS MOSAICS

VIDREPUR S.A.

POLÍGONO MIJARES. CALLE COMERCIO 3. 12550 ALMAZORA (CASTELLÓN) SPAIN
TELÉFONO: +34 964 564 040 · VIDREPUR@VIDREPUR.COM · WWW.VIDREPUR.COM

VIDREPUR OF AMERICA

2301 N.W 84 AVENUE, MIAMI FL.33122 USA · PHONE: 305 639 2926 · FAX: 305 639 4719
INFO@VIDREPUR.US · WWW.VIDREPUR.US

VIDREPUR MEXICO

IMPORTADO POR: VIDREPUR INTERNACIONAL, S.A. DE CV 2DA CERRADA DE PILARES # 15 COL LAS AGUILAS
C.P. 01710, DEL. ALVARO OBREGON, CIUDAD DE MEXICO. (MEXICO) RFC. VIN0401127N8 · MEXICO@VIDREPUR.COM

VIDREPUR OF RUSSIA

УЛ. ВАСИЛИЯ ПЕТУШКОВА, Д.8, Г. МОСКВА, 125476, РОССИЯ
VIDREPUR@MAIL.RU · +7(495) 543-60-10 · +7(916) 003-74-75